



HAL
open science

Integration of a Self-Excited Induction Generator in a Low Power Multisource Remote Site

Remus Pusca, Ezzeddine Touti, Vadim Cazac, Petru Livinti, Ilie Nuca, Raphael Romary

► **To cite this version:**

Remus Pusca, Ezzeddine Touti, Vadim Cazac, Petru Livinti, Ilie Nuca, et al.. Integration of a Self-Excited Induction Generator in a Low Power Multisource Remote Site. 2018 XIII International Conference on Electrical Machines (ICEM), Sep 2018, Alexandroupoli, France. pp.257-262, <10.1109/ICELMACH.2018.8507257>. <hal-04296749>

HAL Id: hal-04296749

<https://univ-artois.hal.science/hal-04296749v1>

Submitted on 20 Nov 2023

HAL is a multi-disciplinary open access archive for the deposit and dissemination of scientific research documents, whether they are published or not. The documents may come from teaching and research institutions in France or abroad, or from public or private research centers.

L'archive ouverte pluridisciplinaire **HAL**, est destinée au dépôt et à la diffusion de documents scientifiques de niveau recherche, publiés ou non, émanant des établissements d'enseignement et de recherche français ou étrangers, des laboratoires publics ou privés.



HAL Authorization

Integration of a self-excited induction generator in a low power multisource remote site

R. Romary, R. Pusca, E. Touti, V. Cazac, P. Livinti, I. Nuca

Abstract – In this paper a comprehensive analysis and a testing process are proposed for investigation of a self-excited induction generator working as integrated source in a low power multisource remote site. For its integration, a reliable scheme is defined and several tests are carried out with a laboratory test bench to evaluate the induction generator stability. The analysis defines a preferential operation area for each machine and the testing process reveals the evolution of the voltage stability during transients by a comparative study between autonomous mode and a mode where the induction generator is connected to a multisource DC bus.

In order to avoid the voltage collapsing and the demagnetization of the machine it is necessary to identify its parameters and to define its operating working area where the best stability can be obtained as well as the limits of the load variation. The analytical model used to provide the working area is presented in the paper and also the experimental results which show the significant incensement of the load variation interval for the self-excited induction generator connected to a multisource site.

Index Terms—Electric machines, induction generator multisource site, self-excitation.

I. NOMENCLATURE

l^r	rotor leakage inductance
l^s	stator leakage inductance
r^s	stator resistance
r^r	rotor resistance related to the stator
p	pair poles number
s	rotor slip
ω	stator angular frequency
C	capacitor
L	inductive load
L^s	cyclic magnetizing inductance
R	resistive load
IM	induction machine
IG	induction generator
SEIG	self-excited induction generator
OP	operating point
Ω'	rotor angular speed

This work was supported in part by the contract 19AUF-IFA.

R. Romary and R. Pusca are with the EA 4025 Laboratory of Electrotechnical and Environmental Systems, University of Artois, Béthune F62400, France (e-mail:raphael.romary@univ-artois.fr, remus.pusca@univ-artois.fr).

E. Touti is with Department of Electrical Engineering, LISIER, University of Tunis, Tunisia (e-mail: touti.these09@gmail.com).

P. Livinti is with the Universiy Vasile Alexandri, Bacau, Romania (e-mail: livinti_petru@yahoo.com).

I. Nuca, V. Cazac are with the Technical University of Moldova, Chisinau, Moldova (e-mail: ilie.nuca@ie.utm.md, vadim.cazac@ie.utm.md)

II. INTRODUCTION

THE use of the wind generators in the production of electrical energy during the last decades had an important upgrowth. It is due to technological and industrial developments which impose an incensement in the demand of energy but also to an awareness of environmental problems [1]. In this context the wind energy seem to be a promising alternative source to accompany the classical energy sources and the growing mastery of technical knowledge that makes it easier to integrate them into the grid [2, 3].

In the case of wind turbines connected to the grid the first electrical machines used was the Induction Machines (IM). It's structure is from the mechanical point of view robust and it requires low maintenance. Furthermore IM can be connected directly to the grid without being confronted with the problems of the amplitude and the frequency of the voltage. Generally these generators are squirrel cage rotor structures with some modifications compared to a machine used as a motor but which are jealously guarded by the manufacturers [4].

Permanent magnet generators can also be a solution for wind energy application but for this machine the induced voltage amplitude increases linearly with the generator speed and the frequency varies [5].

The use of IM as generator connected to the grid is today a classic working system and the new technical challenge is its implementation in a remote site for operation as autonomous source or for their integration into power multisource system because there is serious difficulty for electrical regulation. The interest for this machine is that it has simple structure, high power density, low cost and requires low maintenance [6, 7]. So Induction Generator (IG) seem to be a good compromise especially where the structure robustness is favored in the choice of the machine [8].

When the wind turbine is used in an off grid configuration, either permanently or occasionally, accurate and robust regulation is necessary in order to avoid the machine dropping out. The voltage parameter regulation option as it was experienced in several remote sites (island and artic for example) is a safe, reliable and relatively simple technology but it does not optimize the wave voltage quality and can create the voltage instability/ collapse. These difficulties are due to the inverse nature of the problem (frequency, slip and voltage unknown) [9, 10].

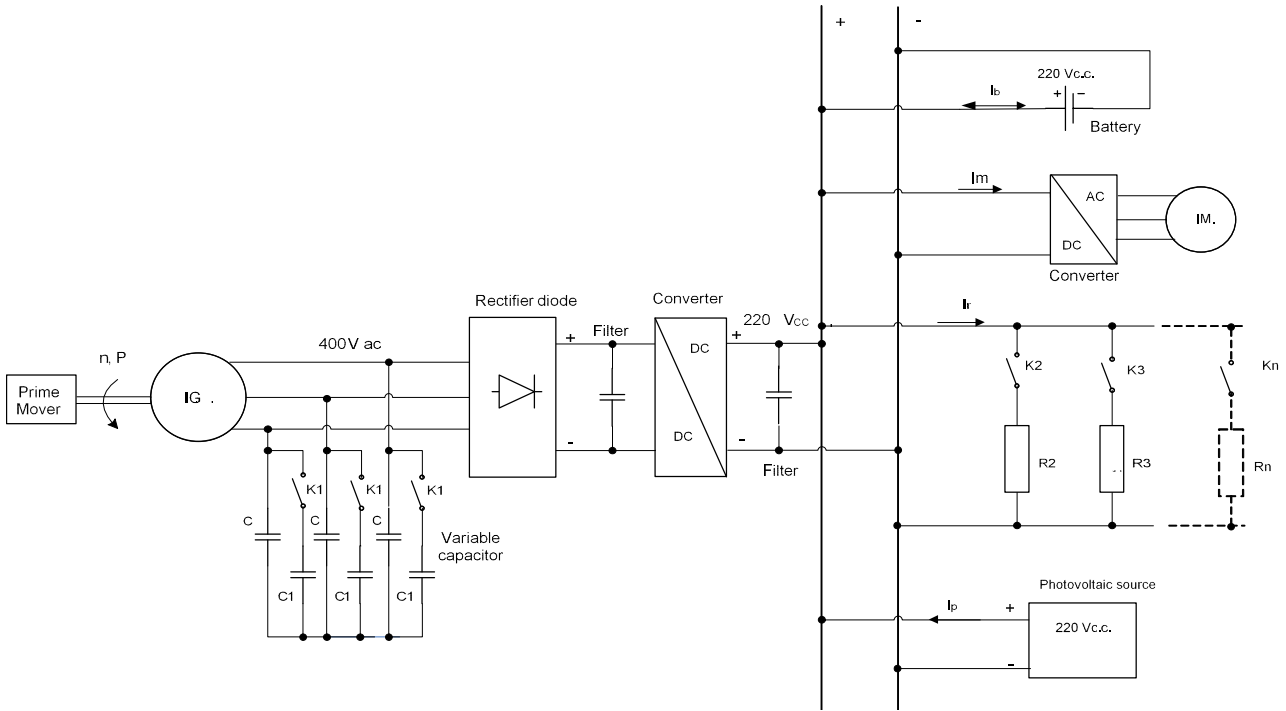

Fig. 1 diagram of self-excited induction generator connected with the low power multi-source system

To stabilize the voltage, in most of the cases, complex techniques using modulated inverters and sliding mode controllers are proposed [11]-[13]. However these solutions are not adapted in the remote sites and don't take in consideration the machine parameters to consider its operating area [14].

In order to face and solve the unstable operation of the wind turbine generator a new approach is described in this paper which treats the behavior of a **Self-Excited Induction Generator (SEIG)** integrated in a remote low power system combining the advantages of preferential operating point with those of the electronic controllers.

For reducing diesel use in remote site, the system needs a hybrid energy solution with high reliability. The choice of the SEIG operating area is presented in Section IV and the experimental results obtained for voltage variation/collapse when IG is connected to a small grid in the Section V.

III. LOW POWER MULTISOURCE SITE

The integration of the SEIG in an autonomous low power multisource system proposed in this paper is presented in Fig. 1. That can be realized using an electronic load controller composed of a rectifier diode and a DC/DC converter which enables the connection of the SEIG to a DC bus. In this scheme the battery imposes the bus DC voltage level and the photovoltaic source is one of the multisource system which can be connected to the bus. The connection of a diesel generator is possible and can be realized if it is needed to ensure the sustainability of power delivery. As load, a resistive (heating) load and an induction motor (pump) is considered. The capacitor bank C delivers the reactive power required by the SEIG. Its value must be adjusted for the

SEIG stability and in the case of procedure for self-excitation after dropping out.

The aim of this work is to define the limits in which the elements R and C can vary when the SEIG is connected to another local sources, taking in consideration the voltage stability, the maintaining of the SEIG in a stable working area and the maintaining a good energetic performances.

IV. CHARACTERIZATION OF IG

A. Equivalent circuit model

For modeling the three-phase induction generator, the single phase equivalent scheme which uses the concept of voltage source presented in Fig.2 is used [15].

This type of operation requires to connect to the stator terminals of the machine, in addition to the load, a capacity capacitor bank C whose function is to provide the reactive power necessary for the SEIG magnetization but also that requested by the load.

This IM model neglects the iron losses and is characterized by following parameters:

$X^s = L^s \omega$, with L^s the cyclic magnetizing inductance,

$x^s = l^s \omega$ with l^s the stator leakage inductance,

$x^r = l^r \omega$ with l^r the rotor leakage inductance related to the stator,

r^s and r^r are the stator and rotor resistances related to the stator and parameter. K is defined by

$$\begin{cases} \underline{K} = \underline{l}^r / \underline{l}^s \\ \underline{K} = -jL^s s \omega / [r^r + j(L^s + l^r) s \omega] \end{cases} \quad (1)$$

where s denotes the slip from rotor angular speed $\Omega' = (1-s)\Omega$ and the synchronous one $\Omega = \omega / p$. The SEIG is characterized by following equations:

$$\begin{cases} \underline{V}^s = r^s \underline{I}^s + jx^s \underline{I}^s + \underline{E}_R^s \\ \underline{E}_R^s = \underline{E}_{(s)}^s + \underline{E}_{(r)}^s \end{cases} \quad (2)$$

where:

$$\begin{cases} \underline{E}_{(s)}^s = jX^s \underline{I}^s \\ \underline{E}_{(r)}^s = jX^s \underline{I}^{r'} \\ \underline{E}_R^s = jX^s \underline{I}_R^s \end{cases} \quad (3)$$

and

$$\underline{I}_R^s = \underline{I}^s + \underline{I}^{r'} \quad (4)$$

Here \underline{I}_R^s is a fictitious stator current which leads to the same magnetic effects that those created simultaneously by \underline{I}^s and $\underline{I}^{r'}$,

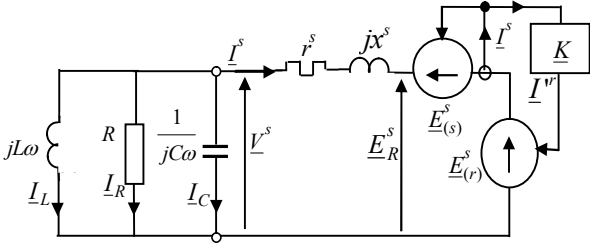

Fig. 2 IM single phase equivalent circuit with parallel R-L load

B. Definition of the operating working area

Taking in consideration the expressions (1) to (4) and considering the real and imaginary part of the complex variables deduced from time phasor diagram, the following equations can be obtained:

$$\begin{cases} s^2 \omega^4 RLCA' + s^2 \omega^2 [LE'' - RA'] + s \omega^2 LL^s r^{r'} - \\ - \omega^2 RLCD' + RD' + (R + r^s) Lr^{r'} = 0 \\ s^2 \omega^4 LA'' - s \omega^4 LB + s^2 \omega^2 r^s E' + s \omega^2 L^s Rr^{r'} - \\ - \omega^2 LD'' + Rr^s r^{r'} = 0 \end{cases} \quad (5)$$

with constant A'' , B , and D'' and E'' given by:

$$\begin{cases} A'' = L^s (1 + \lambda^r) \left\{ L^s \left[1 - (1 + \lambda^s)(1 + \lambda^r) \right] - r^s RC(1 + \lambda^r) \right\} \\ B = L^s RCr^{r'} \\ D'' = r^{r'} \left\{ L^s (1 + \lambda^s) + r^s RC \right\} \\ E'' = L^s (1 + \lambda^r)^2 \left[R + r^s \right] \end{cases} \quad (6)$$

The quantities A' , D' and E' , result from A'' , D'' and E'' considering $r^s = 0$. It is assumed that $I^s = \lambda^s L^s$ and

$I^{r'} = \lambda^r L^s$ where λ^s and $\lambda^r \ll 1$.

The analysis of Equ. (5) can conclude that ω and s depend only on the load (R, L), the capacitor C and the IM parameters. Therefore when these elements are imposed, the SEIG will be locked on fixed ω and s , so only the output voltage will be affected by wind power.

C. Impact of the load variation

Considering the first relation of Equ. (5) it can be written:

$$M_1 \omega^4 + N_1 \omega^2 + P_1 = 0 \quad (7)$$

where M_1 , N_1 and P_1 are given by:

$$\begin{cases} M_1 = LRCA' s^2 \\ N_1 = (LE'' - RA') s^2 + LL^s r^{r'} s - RLCD' \\ P_1 = RD' + L(R + r^s) r^{r'} \end{cases} \quad (8)$$

Taking into account that A' and also M_1 are negative it is considered only the positive ω value, so the root of (7) can be defined as:

$$\omega_1 = \left[-N_1 \left\{ 1 + \sqrt{1 - 4M_1 P_1 / N_1^2} \right\} / 2M_1 \right]^{1/2} \quad (9)$$

Considering the second relation of Equ. (5) it can be written:

$$\omega_{2(1 \text{ or } 2)} = \left[-N_2 \left\{ 1 \pm \sqrt{1 - 4M_2 P_2 / N_2^2} \right\} / 2M_2 \right]^{1/2} \quad (10)$$

where M_2 , N_2 and P_2 are given by:

$$\begin{cases} M_2 = Ls(A'' s - B) \\ N_2 = r^s E' s^2 + L^s Rr^{r'} s - LD'' \\ P_2 = Rr^s r^{r'} \end{cases} \quad (11)$$

In Equ. (10) it is associated the lower index 1 between brackets with the sign + before the radical whereas the sign with the index 2.

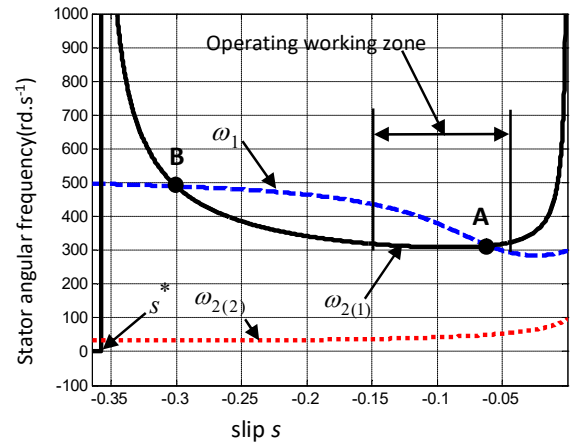

Fig. 3 Stator angular frequency variation for RL load connected at the SEIG output; $C=87.5\mu F$.

The graphic representation of ω solutions expressed by Eqs. (9) and (10) for a RL load is presented in Fig.3 and for only R load in Fig.4 and Fig.5. This analytical study has been realized considering the parameters of the SEIG presented in Appendix. For RL load the used values are: $R=111\Omega$, $C=87.5\mu\text{F}$ and $L=0.17\text{ H}$. We can notice a possible variation area of the slip called “operating working area” where it is possible to maintain the angular frequency quasi-constant. This is the proposed area where IG can maintain good stability for load or wind power variation. The second solution gives a high ω value which is far from $\omega_{rat} = 314.2\text{ rds}^{-1}$.

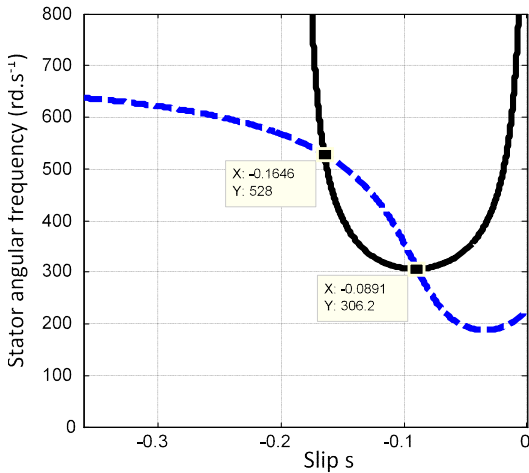

Fig. 4 Stator angular frequency variation for R load connected at the SEIG output; $C=38\mu\text{F}$, $R=76\Omega$.

Another study is presented in Fig. 4 where only R load is connected to the SEIG. It is simulated for $R=76\Omega$, and $C=38\mu\text{F}$ values which allows the SEIG to work near the minimum value of the curve in the steady area. However lows slip area variation is possible to maintain constant ω and so to maintain the Operation Point (OP) within the stable area.

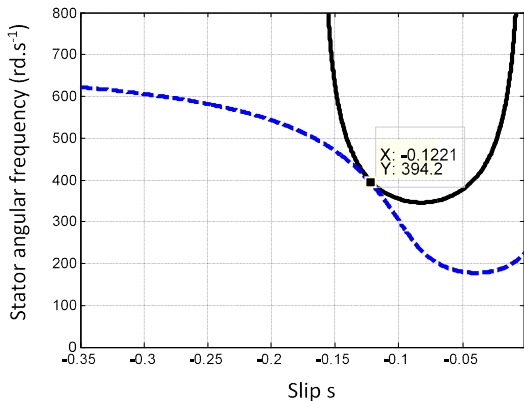

Fig. 5 Stator angular frequency variation for R load connected at the SEIG output; $C=38\mu\text{F}$, $R=64\Omega$.

The case where the capacitor C is maintained constant and

the resistive load varies is presented in Fig. 5. In this case decreasing R leads to an operating point where the curves are tangent at a point whose ω is 394.2 rd/s (62.8 Hz). Then, the SEIG energy performances are low and the voltage stability is rapidly lost in transitory state.

From analysis of Fig. 3, 4 and 5 we can remark that the presence of an inductive load (L) in the system allows the increase of the stability area where the SEIG can operates with load or wind power variations. A resistive load (R) enables more limited interval variation of OP and the use of a fixed capacitor increases the SEIG instability.

V. EXPERIMENTAL STUDY

A. Test bench presentation

Considering a multisource remote site like a farm-house with low installed power, the priority for this kind of plant is the reliability of the system and the continuity in the power supply. In order to ensure these priorities the SEIG must be used in a stable working area and the transitory state can be improved using complementary supply source. This can be obtained by integration of the SEIG in the multi-source system proposed in Fig. 1. Here the capacity is fixed in order to set the operating point close to SEIG rated values (V_{rat} , ω_{rat}) and it can be modified as function of the load variation. The picture of the experimental bench used in the tests is presented in Fig. 6

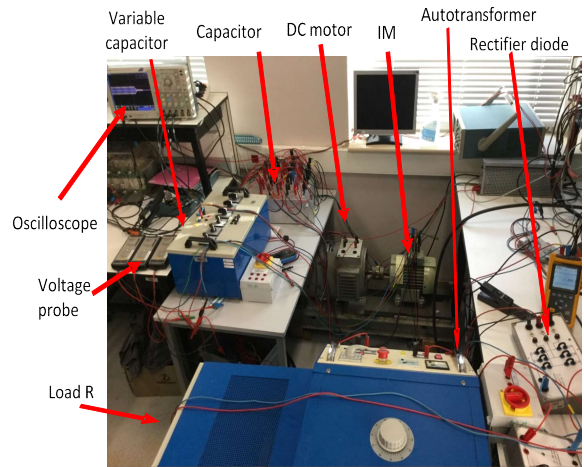

Fig. 6 Experimental bench test of SEIG connected to a DC bus.

For experimental tests, a multi-source bench is used. It is composed of an Induction Generator connected to the DC bus via a PD6 rectifier and a filter element at the voltage output and a DC voltage source. This source is obtained using an autotransformer allowing to set the bus voltage at request value, a rectifier and a filter. The objective of the experiments is to test the limits of the SEIG stability connected to DC bus in order to prevent the IM from high damaging transients which appear during the variation of the wind power or the load change. As prime mover for IM a DC motor is used. In order to ensure the supply of the DC bus a second autotransformer connected to a second PD6 rectifier giving a test voltage $V_b = 220\text{V}$ is used. The bus voltage is

slightly lower than the Induction Generator output voltage. It corresponds to $U_g = 244V$. The variable resistive load R allows power variations of 5% 10% 15% 20% and 25% of the nominal power of 2kW. The two capacitor banks allowing a capacity variation from $5\mu F$ to $180\mu F$ provides the necessary reactive power for the machine. The change in capacity is used to set an initial operating point of the SEIG ($V_g = 244V$). The voltages are recorded using the oscilloscope and three voltage probes.

B. SEIG stability performance during R load variation

It is shown in Fig. 3 that inductive loads have a stabilizing effect for the SEIG during transients. So the test was done considering most unfavorable case for SEIG stability where only R varies.

Figure 7 shows the SEIG stability obtained for a decrease of R from no load to 198Ω load (corresponding to 15% of 2kW) for constant reactive power operation. Here the SEIG is not connected to the DC bus. A variation of the reactive power in accordance with the variation of the resistive load ($tg(RC) = cst$) can be a complementary solution to improve the stability of the voltage and the frequency.

For operation of the SEIG connected to a multisource system, it is proposed to use a PD6 rectifier diode and a step-down chopper in order to stabilize the voltage at the value of the DC bus. A MPPT control for maximum power delivery is proposed for the chopper control to improve the reliability of the installation, the autonomy and the maintaining of a good energy efficiency of the system. The experimental results obtained for SEIG connected to DC bus are shown in Fig. 8.

Now the resistive load is connected to the DC bus and the SEIG test starts by the no load case with nominal voltage set at 244V. This case corresponds to no load case presented in Fig. 7.

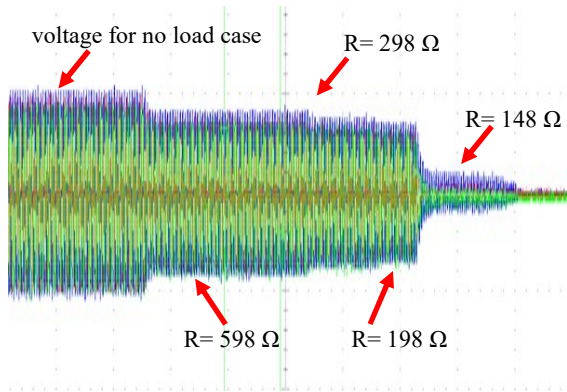

Fig. 7 SEIG voltage evolution for R load variation for SEIG not connected to the DC bus

Then the R variation at 198Ω is achieved. In this case the voltage at the SEIG terminal slightly decreases. The test is repeated by a variation of the load at 119Ω (25% 500W) and at 60Ω (50%, 1000W) to analyze SEIG stability. We can remark a voltage decrease with stabilization at the DC bus voltage set to 220V upon application of 10% load. The stability of the machine is maintained for 50% load variation corresponding to $R=60 \Omega$. However, a greater variation of

the load, leads to a voltage collapse and the machine dropping out. This case presented in Fig. 9 correspond to $R=37 \Omega$ (65% 1300W, 220V).

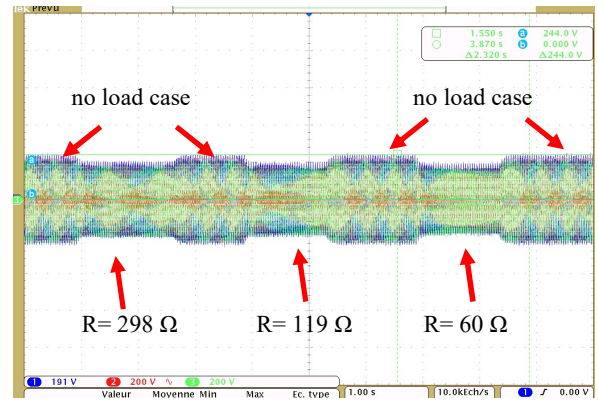

Fig. 8 SEIG voltage evolution for R load variation for SEIG connected to the DC bus.

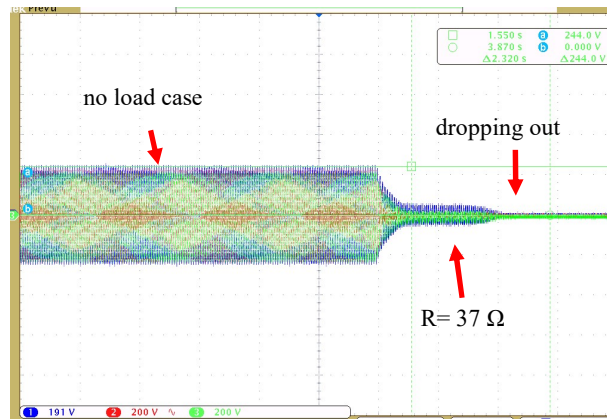

Fig. 9 SEIG voltage collapse for 65% or load variation for SEIG connected to the DC bus.

A comparative analysis between the cases presented in Fig. 7 , 8 and 9 shows that for a low power DC bus, high R variations (Fig. 9) lead to the SEIG disengagement. However the connection of the SEIG to a DC bus (Fig. 8) compared to the case where the SEIG is not connected (Fig. 7) greatly increase the stability of the voltage for a large interval of R load variation. This case is among the most disadvantageous case. The performances can be increased if an inductive load L is connected to the SEIG or/ and if a simultaneous reactive power (C) regulation is realized in order to set the SEIG operation point within the stable operating area presented in Fig. 3. The advantage of system presented in Fig. 1 is that it improves the voltage and generator stability by widening the operating range of frequency and slip, so only the voltage constraint has to be treated.

VI. CONCLUSION

This paper proposes a reliable scheme for integration of a Self Excited Induction Generator in a low power multisource site. The integration is insured through an electronic converter connected to the common DC bus of the remote

site and taking in consideration the induction machine performances. In order to avoid the generator voltage collapse and its demagnetization during transitory state, an operating area must be defined by analytical study in correlation with each Induction Generator and its load. The experimental tests revealed the possibility to increase considerably the stability of the voltage for a large interval of R load variation if the performances of the machine are considered in the system or if the reactive power is controlled.

VII. APPENDIX

The parameters of the IM used in analytical et experimental study are: $380V / 660V$, $7.3A / 4.2A$, $\cos\phi = 0.8$, $p = 2$, $50Hz$, $1420rpm$, $3kW$, $r^r = 3\Omega$, $L^s = 534mH$, $r^s = 8.66\Omega$, $r^{rr} = 6\Omega$, $l^s = 24.24mH$, $l^{rr} = 36.36mH$, $\lambda^s = 0.0454$, $\lambda^r = 0.068$, $C_0 = 32.52\mu F$ The reference values are : $\omega_{ref} = \omega_{rat} = 314.2rds^{-1}$, $s_{ref} = 5.4\%$.
 $I_{ref}^s = 2.42A$, $V_{ref}^s = 220V$

VIII. ACKNOWLEDGMENT

The authors would like to thanks the “Agence Universitaire de la Francophonie” (AUF) for financial support brought by contract 19AUF.

IX. REFERENCES

- [1] N.Laverdure, D.Roye, S.Bacha, R.Belhomme, “Technologie des systems éoliens Integration dans les réseaux électriques”, La Revue 3EI, no 39, pp. 14-25, December 2004.
- [2] T. Ackermann, « Wind Power Systems » Hoboken, NJ : Wiley 2005
- [3] C. Abbey, F.Katirai, C.Brothers, L. Dignard-Bailey, G. Joos, ” Integration on distributed generation and wind energy in Canada” , in Proc. IEEE Power Eng. Soc. Gen. Meet., pp. 7, June, 2006.
- [4] A.Tounzi, "Etude de générateurs électriques pour la conversion de l'énergie éolienne", 1 er Séminaire francophone Formation-Recherche sur l'énergie éolienne, Béthune, France, 25 et 26 novembre 1999, pp. 35-42.
- [5] L.Kalamen, P. Rafajrus, P.Sekerak, V. Hrabovcova, "A novel method of magnetizing inductance investigation of self-excited inductor generators," IEEE Trans.on Magnetics, vol. 48, no.4, pp. 1657-1660, Apr. 2012.
- [6] O. Chatchenine, "Voltage stabilization system for induction generator in stand-alone mode", *IEEE Trans. Energy Convers.*, vol. 24, n.2, pp. 936-944, June 2009.
- [7] R.C. Bansal, “Three-phase self-excited induction generators: An Overview, *IEEE Trans. Energy Convers.*, vol.20, n. 2, pp.292-299, June 2005.
- [8] S. Heir, "Wind energy conversion systems," *John Wiley & Sons, 1998, ISBN:047197143X*
- [9] L.Quazene, G. McPherson, “Analysis of the isolated induction generator”, *IEEE Trans.*, vol. PAS 102, n. 8, pp. 2793-2798, Aug. 1983.
- [10] N. Malik, S. Haque, “Steady state analysis and performance of an isolated self-excited induction generator”, *IEEE Trans. En. Conv.*, vol ECI , n3, pp.134-139, Sept. 1986.
- [11] B. Singh, S. S. Murthy, S. Gupta, “Analysis and implementation of an electronic load controller for a self-excited Induction generator”, *IEE Proc. Gener. Transm. Distrib.*, vol. 151, (1), pp. 51-60, 2004.
- [12] E. G. Marra, J. A. Pomilio, “Self-excited Induction generator controlled by a VS-PWM bidirectional converter for rural

applications”, *IEEE Trans. Ind. Appl.*, vol. 35, (4), pp. 877- 883, 1999.

- [13] B. Venkatesa Perumal, J. K. Chatterjee, “Voltage and Frequency Control of a Stand Alone Brushless Wind Electric Generation Using Generalized Impedance Controller”, *IEEE Trans. Energy Convers.*, vol. 23, (2), pp. 632-641, 2008.
- [14] J. F. Brudny, R. Pusca, H. Roisse, Wind Turbine Using Self-Excited Three-Phase Induction Generators: An Innovative Solution for Voltage- Frequency Control, *Eur. Phys. J. Appl. Phys.*, vol.43, pp.173-187, 2008
- [15] E. Touti, R. Pusca, J. P. Manata, J. F. Brudny, A. Chaari , “Self-excited Induction Generator in Remote Site”, *Reactive power control in AC Power Systems*, Springer Int. Pub. 2017, ISBN 978-3-319-51117-7, pp. 517-545.

X. BIOGRAPHIES

Raphael Romary (M'10) received the Ph.D. from Lille University, Lille, France, in 1995 and the D. SC degree from Artois University, Béthune, France, in 2007. He is currently a Full Professor in Artois University and a Researcher at the Laboratory of Electrical Systems and Environment (LSEE). His research interest concerns the analytical modeling of electrical machines with applications to noise and vibration, losses, electromagnetic emissions, diagnosis.

Remus Pusca was born in Medias, Romania, in 1972. He received in 1995 the electrical engineering degree from Technical University of Cluj-Napoca, Romania. He obtained in 2002 Ph.D. degree in electrical engineering, from the University of Franche-Comté, France. In 2003, he joined the Laboratory of Electrical Systems and Environment (LSEE), Artois University, Béthune, France, as an Associate Professor and Researcher. His research interest is control of electrical systems and diagnosis of electrical machines.

Ezzeddine Touti received the B.S. and Master's degrees in electrical engineering in 1997 and 2005 from the Higher National College of Engineers of Tunis (Tunisia) and the National College of Engineers of Tunis (Tunisia) respectively, all in electrical engineering. He received the Ph.D. Degree in induction generators, power quality and electric drives from the National College of Engineers of Monastir (Tunisia) and Artois University (France) in 2013. In 2014, he joined the Laboratory of Industrial Systems Engineering and Renewable Energies (LISIER), University of Tunis, Tunisia, as an Assistant Professor and Researcher. His research interests are control of electrical systems, power electronics and renewable energy.

Vadim Cazac was born in Soldănești , Moldova, in 1987. He received the B.E. degree in Electrical Machines and Drives from the Technical University of Moldova, Chişinău, Moldova, in 2010, and the master degree in Electrical Engineering from the Tehnical University of Moldova Chişinău, Moldova, in 2012, respectively. In 2012, he joined the Department of Electromechanics, Tehnical University of Moldova, as a Lecturer. From 2012 till 2015 doctorate at specialty, Electrotechnical devices and equipment at Technical University of Moldova His current research interests include power electronics, electrical machines and drives and power quality.

Petru Livinti was born in Codaesti, Romania, in 1956. He receives the diploma of engineer from the Polytechnic Institute of Iasi in 1981. He receives the Ph.D. degree in Automatic Systems from the Gheorghe Asachi Technical University of Iasi in 1999. In 2015 he receives the “habilitation degree” in Electrical Engineering from the Technical University of Cluj-Napoca. Now he is professor at the "Vasile Alecsandri" University of Bacau. The technical skills and competences are: Electrical Machines, Electrical Engineering, Modelling and simulation of electric Drive systems, Wind turbines, Photovoltaic systems, PLCs, Data acquisition systems, Industrial robots, Fuzzy control and Static frequency converter.

Ilie Nuca received the B.S. degree from the Technical University of Moldova, Chişinău in 1979 and PHD degree from the Moscow Power Engineering University in 1988, both in Electrical Machines. He joined the Electrical and Power Faculty of the Technical University of Moldova University, where he is currently an Associate Professor and the Director of the Department of Electrical Engineering. He research interests are in special electrical machines for submersible robots and EV drives, traction systems of urban electric vehicles, electromechanical automated systems with low energy consumption, wind and PV renewable energy.