



HAL
open science

Performance Improvement of Sensorless Vector Control for Induction Motor Drives using Fuzzy-Logic Luenberger Observer: Experimental Investigation

Younes Azzoug, Arezki Menacer, Tarek Ameid, Abdelkarim Ammar

► To cite this version:

Younes Azzoug, Arezki Menacer, Tarek Ameid, Abdelkarim Ammar. Performance Improvement of Sensorless Vector Control for Induction Motor Drives using Fuzzy-Logic Luenberger Observer: Experimental Investigation. 2019 International Conference on Applied Automation and Industrial Diagnostics (ICAAID), Sep 2019, Elazig, Turkey. pp.1-6, 10.1109/ICAAID.2019.8934966 . hal-04294400

HAL Id: hal-04294400

<https://univ-artois.hal.science/hal-04294400v1>

Submitted on 19 Nov 2023

HAL is a multi-disciplinary open access archive for the deposit and dissemination of scientific research documents, whether they are published or not. The documents may come from teaching and research institutions in France or abroad, or from public or private research centers.

L'archive ouverte pluridisciplinaire **HAL**, est destinée au dépôt et à la diffusion de documents scientifiques de niveau recherche, publiés ou non, émanant des établissements d'enseignement et de recherche français ou étrangers, des laboratoires publics ou privés.

Copyright

Performance Improvement of Sensorless Vector Control for Induction Motor Drives using Fuzzy-Logic Luenberger Observer: Experimental Investigation

Younes AZZOUG
Laboratory of Electrical Engineering of
Biskra, LGEB
University of Biskra
Biskra, Algeria
younes.azzoug@univ-biskra.dz

Arezki MENACER
Laboratory of Electrical Engineering of
Biskra, LGEB
University of Biskra
Biskra, Algeria
menacer_arezki@hotmail.com

Tarek AMEID
Laboratory of Electrical Engineering of
Biskra, LGEB
University of Biskra
Biskra, Algeria
tarek.ameid@ieec.org

Abdelkarim AMMAR
Signal and Systems Laboratory
Institute of Electrical and Electronics Engineering
Boumerdes, Algeria
a.ammar@univ-boumerdes.dz

Abstract—In recent years, the industrial dire need of sensorless techniques, make them more popular and universal, for high-performance sensorless vector control of induction motor drive, this paper investigates the application of fuzzy logic controller in the adaptive mechanism of Luenberger state observer, in order to ameliorate the estimation of rotor speed. The fuzzy logic adaptive mechanism performances are compared to those based on the PI controller. The obtained estimation results by PI and fuzzy adaptive mechanisms through hardware implementation with dSpace 1104 are recorded and compared under a variety of operating conditions. The experimental results show that the performances of the fuzzy sensorless indirect rotor field oriented controlled induction motor in terms of response, relative error, overshoot and torque ripples are very promising.

Keywords—Induction motor; adaptive observer; sensorless vector control; fuzzy logic controller; Luenberger observer; real time;dSpace 1104.

I. INTRODUCTION

The three-phase asynchronous motor is extensively used in the industry, its simplicity of construction, low cost and least maintenance, ruggedness, high performances and remarkable reliability are all advantages that convince manufacturers to use this type of engines [1-4]. Its major advantage is represented in the absence of sliding electrical contacts. Otherwise, the induction motor has also a few limitations such as the nonlinearity system, and multivariable mathematical model [5], these problems can be resolved by many technique of machine control, particularly the field oriented control (FOC), which allowed to get the decoupling between the flux and the torque, an independent control [6] like direct current (DC) machine and high performance in variable speed.

The closed-loop control of the induction motor requires the knowledge of the rotor speed and/or position, which leads us to add an advice that can provide this information like the incremental encoder, the tachometer, or resolver... The implementation of one of these sensors, which is usually the

incremental encoder to measure the rotor velocity can cause several problems such as the requirement of a high cost, the speed sensor needs an additional place, furthermore, due to its sensitivity it is not recommended to work in sever environments [7].

To avoid all these problems, several methods have been suggested recently for state estimation of sensorless induction motor drives, specifically aimed at determining the motor speed like Luenberger state observer (LSO) [8], model reference adaptive system (MRAS) [9], extended Kalman filter (EKF) [10], sliding mode observer (SMO) [11], and observers based on artificial intelligence like neural network (NN), and fuzzy logic (FL) [12].

The proposed estimator in this paper is the Luenberger observer; its stability is provided and guaranteed by the Lyapunov theory. The adaptive mechanism is traditionally implemented by proportional-integral (PI) controller. However, the parameter variation such as stator resistance can effect speed estimation accuracy. In order to get good performance estimator, a fuzzy logic controller (FLC) is used in this work to estimate the rotor velocity without a need of other parameters estimation, the proposed algorithm has been compared to the conventional one using a PI controller. The global control scheme is examined by an experimental implementation.

II. THE INDIRECT FIELD ORIENTED CONTROL

A. Induction motor model dedicated for the control

Among the various forms of models used to represent the induction motor, we will use the one which is presented in the reference frame (d, q) linked to the rotating field, and takes the stator currents, the rotor fluxes and the rotational speed as state variables, the voltages as control variables, this model is expressed by the following system of equations:

$$\frac{d}{dt}I_{sd} = -\lambda I_{sd} + \omega_s I_{sq} + \frac{k_s}{T_r} \psi_{rd} + k_s \omega_r \psi_{rq} + \frac{1}{\sigma L_s} V_{sd} \quad (1)$$

$$\frac{d}{dt}I_{sq} = -\omega_s I_{sd} - \lambda I_{sq} - \omega_r k_s \psi_{rd} + \frac{k_s}{T_r} \psi_{rq} + \frac{1}{\sigma L_s} V_{sq} \quad (2)$$

$$\frac{d}{dt}\psi_{rd} = \frac{M}{T_r} I_{sd} - \frac{1}{T_r} \psi_{rd} + (\omega_s - \omega_r) \psi_{rq} \quad (3)$$

$$\frac{d}{dt}\psi_{rq} = \frac{M}{T_r} I_{sq} - (\omega_s - \omega_r) \psi_{rd} - \frac{1}{T_r} \psi_{rq} \quad (4)$$

$$T_e = p \frac{M}{L_r} (\psi_{rd} I_{sq} - \psi_{rq} I_{sd}) \quad (5)$$

$$\frac{d}{dt}\Omega_r = \frac{1}{J} (T_{em} - T_l) - \frac{f}{J} \Omega_r \quad (6)$$

Where:

$$\lambda = \frac{R_s}{\sigma L_s} + \frac{R_r M^2}{\sigma L_s L_r^2}; \quad k_s = \frac{M}{\sigma L_s L_r}; \quad T_r = \frac{L_r}{R_r}; \quad \sigma = 1 - \frac{M^2}{L_s L_r}$$

And:

I_{sd}, I_{sq} : (d, q) stator currents

ψ_{rd}, ψ_{rq} : (d, q) rotor fluxes

V_{sd}, V_{sq} : (d, q) stator voltages

ω_s, ω_r : synchronous and rotor angular speed

Ω_r : mechanical speed

T_e, T_l : electromagnetic and load torque

B. Vector control principal

The indirect rotor field oriented control (IRFOC) of the induction motor has an objective to make the control similar with the separately excited DC motor, where the control of flux and torque is realized independently.

In this case, the oriented rotor flux implies the following:

$$\psi_{rd} = \psi_r \text{ and } \psi_{rq} = 0 \quad (7)$$

From (3), (5) and (7), the flux and the torque expressions become:

$$\psi_r = \frac{M}{T_r \sigma + 1} I_{sd} \quad (8)$$

$$T_e = p \frac{M}{L_r} \psi_r I_{sq} \quad (9)$$

The electromagnetic torque depends only just on one single current which is the quadratic stator current I_{sq} (9), so the electromagnetic torque is similar to the one of DC machine presented in the following equation:

$$T_e = k' \phi I \quad (10)$$

We have two independent action variables such as the DC machine, one for adjusting the flux (I_{sd}), the other one for adjusting the torque (I_{sq}).

And (4) becomes:

$$\omega_s = \frac{M}{T_r \psi_r} I_{sq} + p \Omega_r \quad (11)$$

With the integral of (11) we get the angle θ_s which will be used in all transformations.

$$\theta_s = \int \omega_s dt \quad (12)$$

III. SENSORLESS INDIRECT FIELD ORIENTED CONTROL (IFOC) USING LUENBERGER STATE OBSERVER

A Luenberger observer is chosen which belongs to the group deterministic of closed loop observers. Its configuration is based on the deterministic model of the system. Measuring the inputs and the outputs, this observer can reconstitute the state of the system. When we have an unknown parameters or unmeasured variable, the Luenberger state observer (LSO) is used to estimate them, like the stator resistance, the rotor flux and speed of an induction motor.

A. (α, β) model of Induction motor

In order to design a high performances speed estimator, and establish a good compromise between stability and simplicity of the observer, a model of the machine drive is defined in the reference linked to the coordinate (α, β) . The IM model is described by the following state equation:

$$\begin{cases} \dot{X} = A(\omega)X + BU \\ Y = CX \end{cases} \quad (13)$$

Where

$$X = \begin{bmatrix} I_{s\alpha} & I_{s\beta} & \psi_{r\alpha} & \psi_{r\beta} \end{bmatrix}^T, Y = \begin{bmatrix} I_{s\alpha} & I_{s\beta} \end{bmatrix}^T,$$

$$U = \begin{bmatrix} V_{s\alpha} & V_{s\beta} \end{bmatrix}^T$$

And

$$A = \begin{bmatrix} a_1 & 0 & a_2 & \omega_r a_3 \\ 0 & a_1 & -\omega_r a_3 & a_2 \\ a_4 & 0 & a_5 & -\omega_r \\ 0 & a_4 & \omega_r & a_5 \end{bmatrix}, B = \begin{bmatrix} \frac{1}{\sigma L_s} & 0 \\ 0 & \frac{1}{\sigma L_s} \\ 0 & 0 \\ 0 & 0 \end{bmatrix},$$

$$C = \begin{bmatrix} 1 & 0 & 0 & 0 \\ 0 & 1 & 0 & 0 \end{bmatrix}$$

Which

$$a_1 = -\left(\frac{1}{T_s \sigma} + \frac{(1-\sigma)}{T_r \sigma}\right), a_2 = \frac{M}{\sigma L_s L_r T_r}, a_3 = \frac{M}{\sigma L_s L_r}, a_4 = \frac{M}{T_r}, a_5 = -\frac{1}{T_r}$$

$$T_s = \frac{L_s}{R_s}, T_r = \frac{L_r}{R_r}, \sigma = 1 - \frac{M^2}{L_s L_r}$$

And

$I_{s\alpha}, I_{s\beta}$: (α, β) stator currents

$\psi_{r\alpha}, \psi_{r\beta}$: (α, β) rotor fluxes
 $V_{s\alpha}, V_{s\beta}$: (α, β) stator voltages
 ω_r : rotor angular speed

B. Speed Luenberger observer

The Luenberger speed observer equation is given by:

$$\begin{cases} \dot{\hat{X}} = A(\hat{\omega}_r)\hat{X} + BU + K\xi_y \\ \hat{Y} = C\hat{X} \end{cases} \quad (15)$$

The symbol $\hat{}$ denote estimated value and K is the observer gain matrix, using the Lyapunov theory to deduce the mechanism of adaptation speed [13]. The stator current and rotor flux estimation error is given by [14]:

$$\dot{e} = (A - KC)e + (\Delta A)\hat{X} \quad (16)$$

With

$$\Delta A = A(\omega_r) - A(\hat{\omega}_r) = \begin{bmatrix} 0 & 0 & 0 & a_3\Delta\omega_r \\ 0 & 0 & -a_3\Delta\omega_r & 0 \\ 0 & 0 & 0 & -\Delta\omega_r \\ 0 & 0 & \Delta\omega_r & 0 \end{bmatrix} \quad (17)$$

Which

$$\Delta\omega_r = \omega_r - \hat{\omega}_r \quad (18)$$

$$e = X - \hat{X} = [e_{I_{s\alpha}} \quad e_{I_{s\beta}} \quad e_{\psi_{r\alpha}} \quad e_{\psi_{r\beta}}]^T \quad (19)$$

Considering the following Lyapunov function:

$$V = e^T e + (\Delta\omega_r)^2 / \lambda \quad (20)$$

Its derivative is as follows:

$$\frac{dV}{dt} = \left\{ \frac{d(e^T)}{dt} \right\} e + e^T \left\{ \frac{de}{dt} \right\} + \frac{1}{\lambda} \frac{d}{dt} (\Delta\omega_r)^2 \quad (21)$$

$$\frac{dV}{dt} = e^T \left\{ (A - KC)^T + (A - KC) \right\} e - 2a_3\Delta\omega_r (e_{I_{s\alpha}}\hat{\psi}_{r\beta} - e_{I_{s\beta}}\hat{\psi}_{r\alpha}) + \frac{2}{\lambda}\Delta\omega_r \frac{d}{dt} \hat{\omega}_r \quad (22)$$

With $\hat{\omega}_r$ is the rotor velocity estimated by the adaptive observer. The rotor speed estimation is given by the Eq. 23, obtained through equality between the second and the third term of Eq. 22:

$$\hat{\omega}_r = \lambda a_3 \int_0^t (e_{I_{s\alpha}}\hat{\psi}_{r\beta} - e_{I_{s\beta}}\hat{\psi}_{r\alpha}) dt \quad (23)$$

Where, λ is a positive constant

The expression (23) is established for a constant velocity, so as to ameliorate the feedback of the rotor position estimation in various condition, the law of the control is modified according to the following relation:

$$\hat{\omega}_r = K_p (e_{I_{s\alpha}}\hat{\psi}_{r\beta} - e_{I_{s\beta}}\hat{\psi}_{r\alpha}) + K_i \int (e_{I_{s\alpha}}\hat{\psi}_{r\beta} - e_{I_{s\beta}}\hat{\psi}_{r\alpha}) dt \quad (24)$$

With K_p and K_i are the positive gains of the PI controller.

The return loop of the gain matrix K is selected to ensure the high dynamics and performances of the global adaptive Luenberger observer (ALO).

$$K = \begin{bmatrix} K_1 & K_2 & K_3 & K_4 \\ -K_2 & K_1 & -K_4 & K_3 \end{bmatrix}^T \quad (25)$$

With K_1, K_2, K_3 and K_4 are given by:

$$\begin{cases} K_1 = (l-1) \left(\frac{1}{\sigma T_s} + \frac{1}{\sigma T_r} \right) \\ K_2 = -(l-1)\hat{\omega}_r \\ K_3 = (l^2-1) \left\{ \left[\frac{1}{\sigma T_s} + \frac{1}{\sigma T_r} \right] \frac{\sigma L_s M}{L_r} - \frac{M}{T_r} \right\} + \frac{\sigma L_s M}{L_r} \left[\frac{1}{\sigma T_s} + \frac{1}{\sigma T_r} \right] (l-1) \\ K_4 = -(l-1) \frac{\sigma L_s M}{L_r} \hat{\omega}_r \end{cases}$$

Where l is a positive factor calculated by using pole placement approach [15]. Finally the overall diagram of full-order Luenberger estimator is shown in Fig. 1.

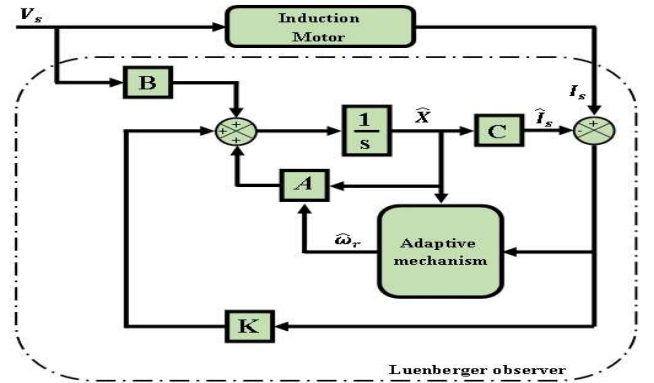

Figure 1. Overall diagram of the adaptive observer

C. Law of control based on fuzzy logic (FL)

The adaptive mechanism of the Luenberger observer is modified by applying the speed setting signal on the FLC, Fig. 2 shows the fuzzy logic controller FLC design.

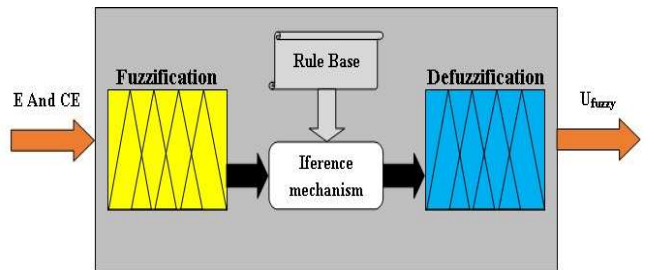

Figure 2. Fuzzy logic controller design

The inputs of FLC are speed tuning signal E and its changes CE , the output is estimated speed $\hat{\omega}_r$. The symmetrical triangular membership functions shown in Fig.3a complete fuzzification and defuzzification processes. Also,

Fig. 3b show a nonlinear surface for the inputs variables and output which is obtained by mapping the relationship between the inputs and the output variables according to the fuzzy rules base shown in Tab. 1. The output and each of the inputs of the FLC are described by 7 membership functions namely respectively: NW (Negative Wide), NM (Negative Medium), NL (Negative Little), Z (Zero), PL (Positive Little), PM (Positive Medium), and PW (Positive Wide). This matrix is elaborate by 7x7 rules.

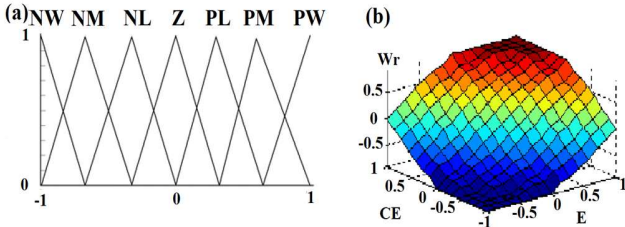

Figure 3. Membership functions of: (a) speed tuning signal, changes of speed tuning signal, and (b) nonlinear surface of inputs/output.

TABLE 1. FUZZY RULES

	NW	NM	NL	Z	PL	PM	PW
NW	NW	NW	NW	NW	NM	NL	Z
NM	NW	NW	NW	NM	NL	Z	PL
NL	NW	NW	NM	NL	Z	PL	PM
Z	NW	NM	NL	Z	PL	PM	PW
PL	NM	NL	Z	PL	PM	PW	PW
PM	NL	Z	PL	PM	PW	PW	PW
PW	Z	PL	PM	PW	PW	PW	PW

IV. EXPERIMENTAL RESULTS

The sensorless IRFOC using Luenberger observer based on fuzzy logic (FL) adaptive mechanism has been applied, analyzed and compared with the one based on PI controller for different variable reference speed and mechanical load torque. As a matter of fact, the experimentation has been achieved by feeding a 1.1 kW induction motor, using Matlab-Simulink and dSpace DS1104 real time controller board. The experimental test bench is shown in Fig.4.

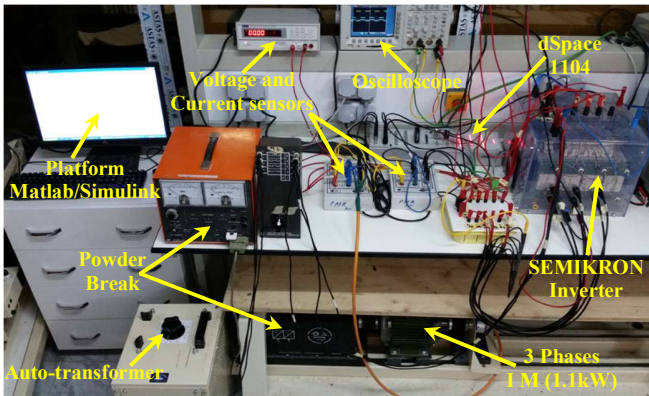

Figure 4. Experimental test bench.

The experimental results of the sensorless IRFOC based on Luenberger observer have been obtained by a high frequency digital oscilloscope across the liaison of digital to analog

converter (DACH) of the real-time interface. The figures below show the induction motor behavior under various drive states, such as the steady state, load application, low-speed and reverse speed test, comparing the classical PI and FL controller applied in the adaptive scheme of LO. The waveforms for the PI controller are shown in Fig.5, and Fuzzy Logic controller in Fig.6.

A. Experimental results of PI controller

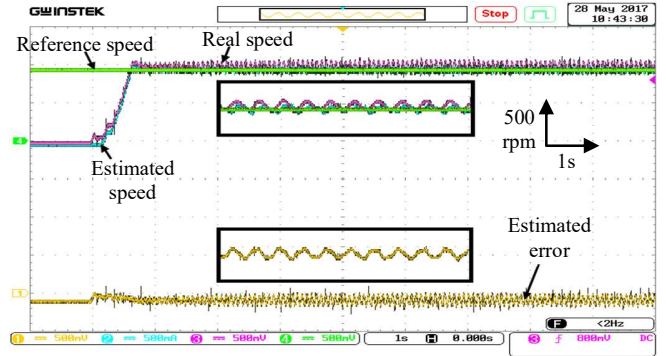

Figure 5(a). Speed response at 1000 rpm with estimation error.

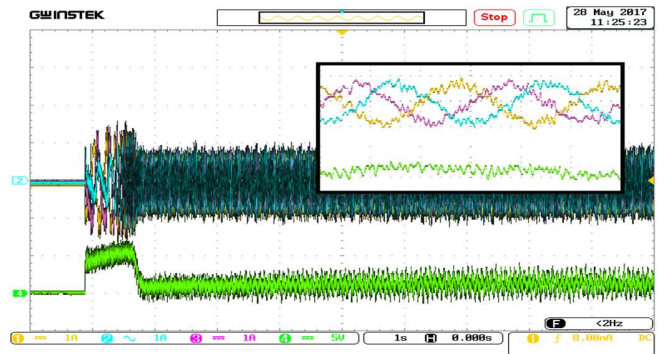

Figure 5(b). Stator phase currents and electromagnetic torque without load application.

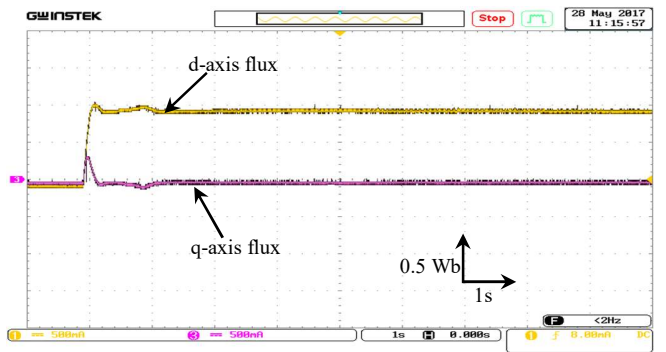

Figure 5(c). Direct and quadratic fluxes.

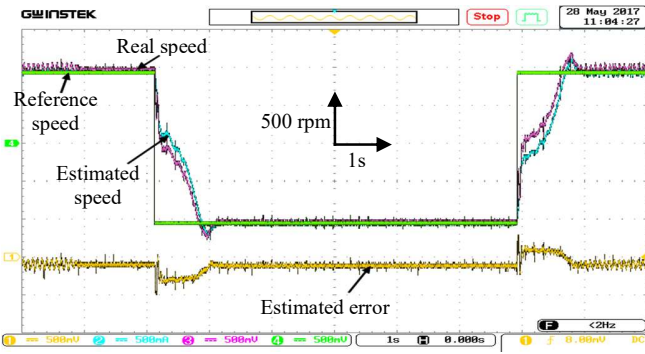

Figure 5(d). Speed response while direction reverse and estimation error.

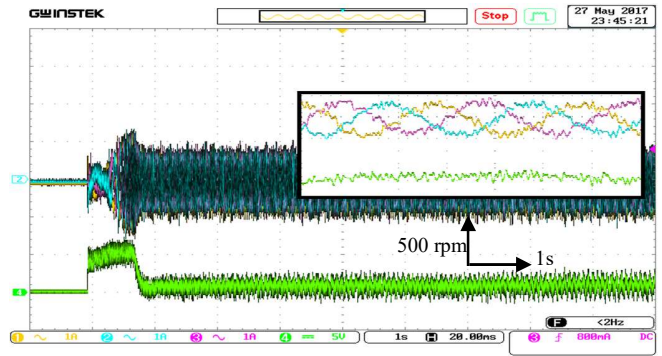

Figure 6(b). Stator phase currents and electromagnetic torque.

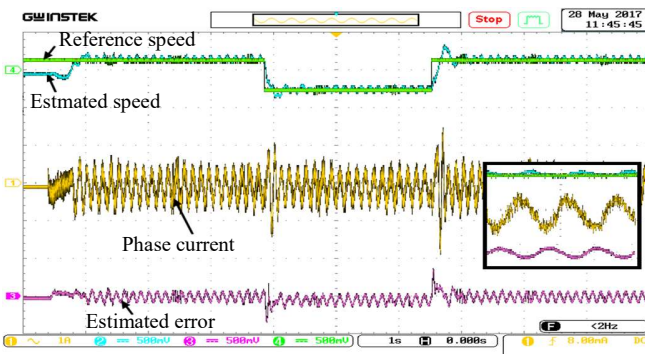

Figure 5(e). Low speed (200 rpm) and reverse speed (-200 rpm).

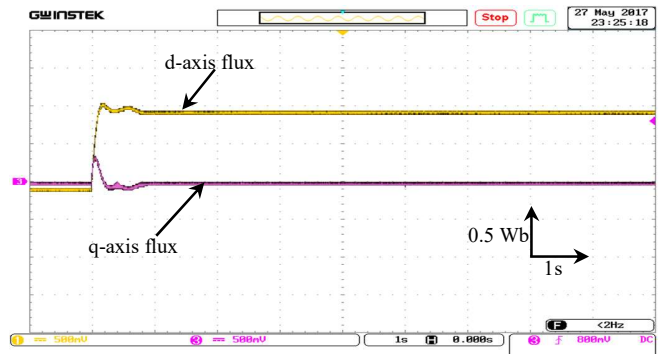

Figure 6(c). Direct and quadratic fluxes.

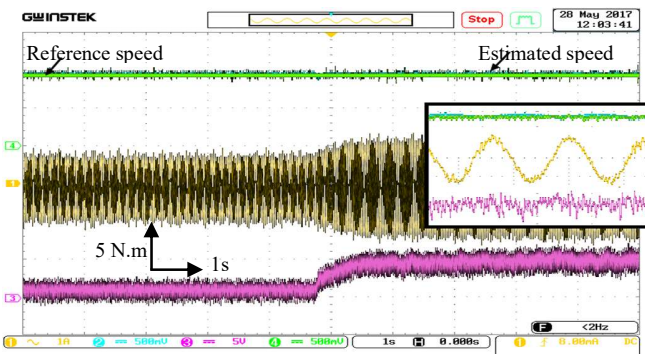

Figure 5(f). 5 N.m load introduction at steady state and 1000 rpm: torque and stator current.

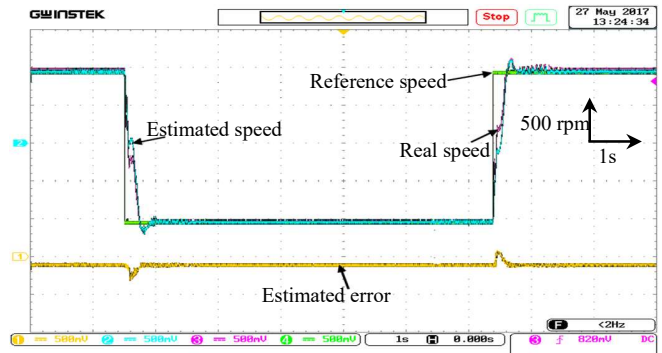

Figure 6(d). Speed response while direction reverse and estimation error.

B. Experimental results of FL controller

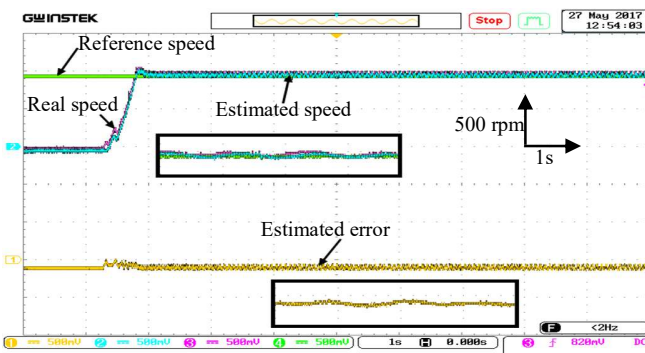

Figure 6(a). Speed response at 1000 rpm with estimation error.

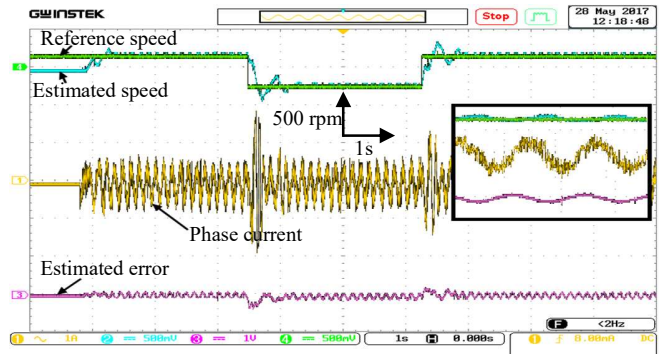

Figure 6(e). Low speed (200 rpm) and direction reverse (-200 rpm).

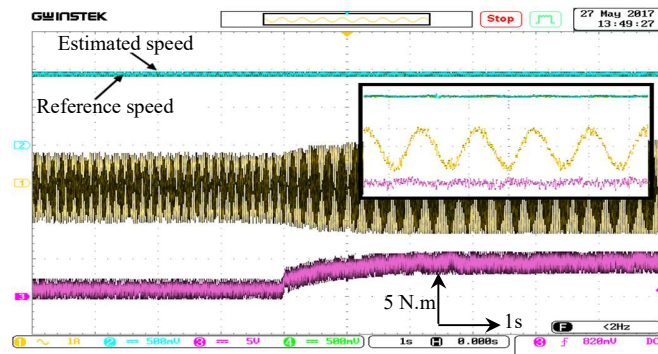

Figure 6(f). 5 N.m load introduction at steady state: Torque and stator current.

Fig.5a and Fig.6a show the convergence of the estimated and measured speed toward the reference progressively from 0 to 1000 rpm, but the error between real and estimated speed at 1000 rpm is 10% for the PI controller, whereas, speed error is 1% for the FL controller.

Besides, Fig.5b and Fig.6b show a stator phase currents and electromagnetic torque performances, it is noted that there is a reduction of ripples in torque and few harmonics in phase currents for FL controller compared to PI controller.

The experimental results shown in Fig.5c and Fig.6c prove that the rotor fluxes converge for their final values ($\psi_{rd} = \psi_r$ and $\psi_{rq} = 0$). Hence, the control is decoupled.

As second test (speed reverse 1000 rpm to -1000 rpm), from Fig.5d and Fig.6d, the speed error is 10% for PI controller with response time of 1.1s, contrariwise, speed error is 1% for FL controller and response time of 0.5s, we deducing that fuzzy controller is more than twice as fast as PI controller.

As seen in Fig.5e and Fig.6e waveforms present the dynamic response of the system at low speed (200 rpm). Speed error of FL controller (5%) is more than twice less than PI controller (12%).

The estimated speed get through the full-order Luenberger observer based on FL adaptive mechanism isn't disrupted by the load torque application and follows perfectly the speed reference (Fig.6f), contrary to the one based on PI controller that shows a small error in the speed (Fig.5f).

V. CONCLUSION

In this work, an experimental Implementation of sensorless indirect field oriented controlled induction motor using Luenberger state observer has been presented, the fuzzy logic controller was used in the adaptive mechanism and compared to the conventional one based on PI controller. Different operation conditions have demonstrated the higher efficiency and better dynamic response of the proposed fuzzy logic adaptive mechanism; this can be proven clearly from the decrease of settling time, overshoot and the relative error compared to the traditional method over a wide range of tests. Therefore, the fuzzy logic can be a good solution to improve the performance of the sensorless drive.

APPENDIX

TABLE 2. INDUCTION MOTOR PARAMETERS

Specifications		Parameters	
Nominal power [kW]	1.1	R_s [Ω]	6.75
Nominal voltage [V]	400	R_r [Ω]	6.21
Nominal current [A]	2.5	L_s [H]	0.5192
Frequency [Hz]	50	L_r [H]	0.5192
Number of pole pairs	2	M [H]	0.4957
Nominal speed [rpm]	1450	J [Kg.m ²]	0.0124
		f [Nm.s.rad ⁻¹]	0.002

REFERENCES

- [1] Z. Kandoussi, Z. Boulghasoul, A. Elbacha, and A. Tajer, "Luenberger observer based sensorless Indirect FOC with stator resistance adaptation", in 2014 Second World Conference on Complex Systems (WCCS), 2014, pp. 367–373.
- [2] T. Ameid, A. Menacer, H. Talhaoui, and I. Harzelli, "Broken rotor bar fault diagnosis using fast Fourier transform applied to field-oriented control induction machine: simulation and experimental study", *Int. J. Adv. Manuf. Technol.*, vol. 92, no. 1–4, pp. 917–928, Sep. 2017.
- [3] H. Talhaoui, A. Menacer, A. Kessal, and A. Tarek, "Experimental diagnosis of broken rotor bars fault in induction machine based on Hilbert and discrete wavelet transforms", *Int. J. Adv. Manuf. Technol.*, pp. 1–10, Nov. 2017.
- [4] Y. Azzoug, A. Menacer, R. Pusca, R. R. Romary, T. Ameid, and A. Amma, "Fault Tolerant Control for Speed Sensor Failure in Induction Motor Drive based on Direct Torque Control and Adaptive Stator Flux Observer," in *2018 International Conference on Applied and Theoretical Electricity (ICATE)*, 2018, pp. 1–6.
- [5] R. Bojoi, P. Guglielmi, and G.-M. Pellegrino, "Sensorless Direct Field-Oriented Control of Three-Phase Induction Motor Drives for Low-Cost Applications", *IEEE Trans. Ind. Appl.*, vol. 44, no. 2, pp. 475–481, 2008.
- [6] F. Blaschke, "The principle of field orientation as applied to the new transvektor closed-loop control system for rotating field machines", *Siemens Rev.*, vol. 34, pp. 217–220, 1972.
- [7] T. Du, "Design and application of extended observers for joint state and parameter estimation in high-performance AC drives", *IEE Proc. - Electr. Power Appl.*, vol. 142, no. 2, p. 71, 1995.
- [8] H. Kubota and K. Matsuse, "Speed sensorless field-oriented control of induction motor with rotor resistance adaptation", *IEEE Trans. Ind. Appl.*, vol. 30, no. 5, pp. 1219–1224, 1994.
- [9] T. Kumar, S. Matani, and G. Datkhile, "Sensorless control of IM using MRAS strategy and its closed loop stability analysis", in 2016 IEEE 1st International Conference on Power Electronics, Intelligent Control and Energy Systems (ICPEICES), 2016, pp. 1–6.
- [10] T. Ameid, A. Menacer, H. Talhaoui, I. Harzelli, and A. Ammar, "Simulation and real-time implementation of sensorless field oriented control of induction motor at healthy state using rotor cage model and EKF", in 2016 8th International Conference on Modelling, Identification and Control (ICMIC), 2016, pp. 695–700.
- [11] W. C. Andrade Pereira et al., "Improved Sensorless Vector Control of Induction motor Using Sliding Mode Observer", *IEEE Lat. Am. Trans.*, vol. 14, no. 7, pp. 3110–3116, Jul. 2016.
- [12] B. Karanayil, M. F. Rahman, and C. Grantham, "Online Stator and Rotor Resistance Estimation Scheme Using Artificial Neural Networks for Vector Controlled Speed Sensorless Induction Motor Drive", *IEEE Trans. Ind. Electron.*, vol. 54, no. 1, pp. 167–176, Feb. 2007.
- [13] A. Ammar, A. Benakcha, and A. Bourek, "Adaptive MRAC-based direct torque control with SVM for sensorless induction motor using adaptive observer", *Int. J. Adv. Manuf. Technol.*, Dec. 2016.
- [14] C. Djamilia, M. Yahia, and T. Ali, "Simultaneous Estimation of Rotor Speed and Stator Resistance in Sensorless Indirect Vector Control of Induction Motor Drives Using a Luenberger Observer", *Int. J. Comput. Sci. Issues*, vol. 9, no. 3, No 2, pp. 325–335, 2012.
- [15] S.-I. A. L. Gelman, *Advances in Electrical Engineering and Computational Science*, vol. 39. Dordrecht: Springer Netherlands, 2009.