

AGENDA (11h-12h15)

I. General presentation of the project (Hamid Boudiba)

- Project scope
- Objectives and outputs
- Main steps
- Partners and roles
- Questions/answers

II. Existing standards to qualify magnet wire. Focus: Mechanical and dielectrical tests (Sonia DJENNAD – LSEE Université d'Artois)

- History of enamels
- Enameling Process
- HI-ECOWIRE Process
- Magnet wire properties
- Tests methods and standards
 - Aging (Thermal, Electrical, Mechanical, Environmental)
 - Electrical tests (Partial Discharge inception voltage, Breakdown voltage, dissipation factor)
 - Thermal tests (thermal index, heat shock, cut through)
 - Mechanical tests (peel test, flexibility)
- Questions/answers

Existing standards to qualify magnet wire. Focus: Mechanical and dielectrical tests



II. Existing standards to qualify magnet wire. Focus: Mechanical and dielectrical tests

Sonia DJENNAD – LSEE Université d’Artois

- History of enamels
- Enamelling Process
- HI-ECOWIRE Process
- Magnet wire properties
- Tests methods and standards
 - Aging (Thermal, Electrical, Mechanical, Environmental)
 - Electrical tests (Partial Discharge inception voltage, Breakdown voltage, dissipation factor)
 - Thermal tests (thermal index, heat shock, cut through)
 - Mechanical tests (peel test, flexibility)
- Questions/answers

History of enamels

- The first insulated wires were introduced into the field of electricity with the invention of the galvanometer in the early 1800s. Silver or copper wires wrapped with silk used for tapestry and furnishing trimmings, although a textile core covered with metal foil (Faraday 1821).
- Copper wire wrapped side by side with a thin string and adding a calico (cotton fabric) between each layer. Each layer has fixed with shellac before moving on to the next (Faraday (1831).
- Cotton fabric impregnated with soft pitch or resin–beeswax mixtures (1831).
- Copper wire covered with silk or cotton produced by bonnet-wire maker (1938).
- The first enamelling machine was run by George Jacobs and in Dudley, Massachusetts, in 1907.

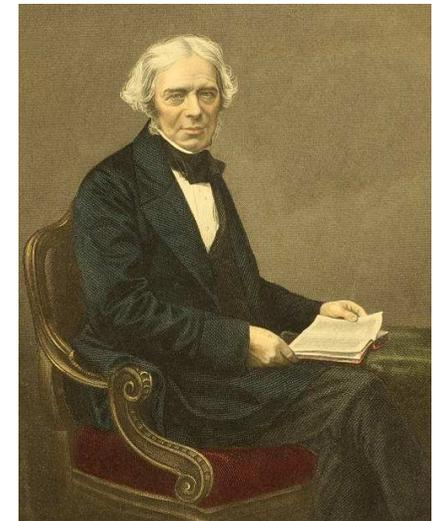
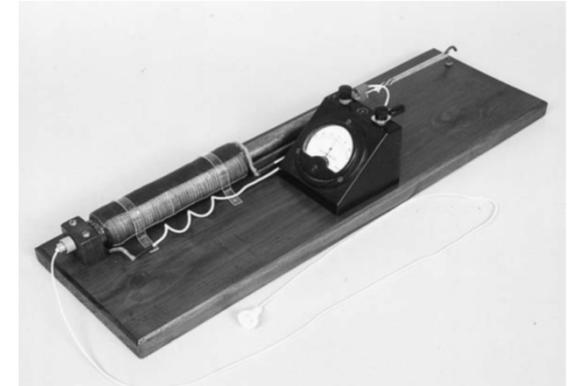

Mickael FARADAY

History of enamels

YEAR	MATERIALS	PROPERTIES	USE TODAY
1838	Textile (Silked, cotton)	Water vapour, capillary penetration	None
1900	Oil-bitumen	Excellent humidity resistance, poor thermal properties	None
1915	Tung oil, copal, phenolic resins	Improved hardness, flexibility and solvent resistance	None
1938	Polyvinyl acetal	Excellent mechanical properties and adhesion, low solids	Reduced
1940	Polyamide	Improved mechanical properties, flexibility, low coefficient of friction, self bonding Overcoat, self bonding	Overcoat self bonding
1950	Polyurethane	Solderable, fast enamelling	Great
1954	Polyester (glycerine)	Excellent solvents and humidity resistance, good thermal endurance	Reduced
1959	Polyimide	Outstanding thermal resistance, high raw material costs	Special application
1961	Poly(ester-imide) (glycerine)	Improved cut through and thermal endurance, increased enamelling speed	Reduced
1965	Poly(ester-imide) (THEIC)	High cut through, hydrolytic stability, Freon resistance	Great
1966	Poly(amide-imide)	Excellent thermal, mechanical properties	Great
1967	Polyester (THEIC)	Improved thermal endurance, adhesion, base coat in dual coat systems (PAI as overcoat)	Great
1968	Polyhydantoine	Excellent thermal properties and adhesion, high raw material cost	None
1973-1980	Alternative enamelling technologies	Hot melts, water and mild solvent enamels, dispersion, powders, extrusion resins, Electrophoretic enamels	None
1988	Corona resistant wire enamels	Resistant to partial discharges in inverter driven motors	Special applications

Anton, K. Lienert, G. Hegemann, "Wire Enamels – An Application for High Performance Polymers Unknown to Chemists", Macromol. Mater. Eng. 2008, 293, 331–339.

II. Existing standards to qualify magnet wire. Focus: Mechanical and dielectrical tests

Sonia DJENNAD – LSEE Université d'Artois

- History of enamels
- Enamelling Process
- HI-ECOWIRE Process
- Magnet wire properties
- Tests methods and standards
 - Aging (Thermal, Electrical, Mechanical, Environmental)
 - Electrical tests (Partial Discharge inception voltage, Breakdown voltage, dissipation factor)
 - Thermal tests (thermal index, heat shock, cut through)
 - Mechanical tests (peel test, flexibility)
- Questions/answers

Enamelling Process

First enamelling process

■ DRAWING AND ANNEALING BY JOULE EFFECT m/sec

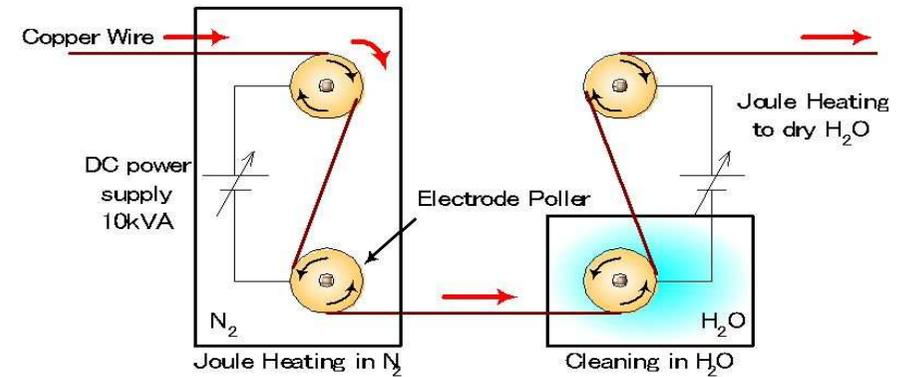
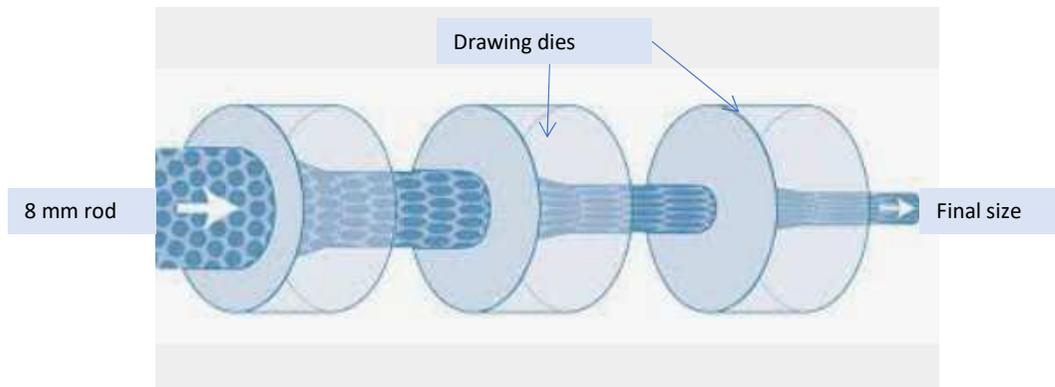

■ LAMINATION FOR STRIPS

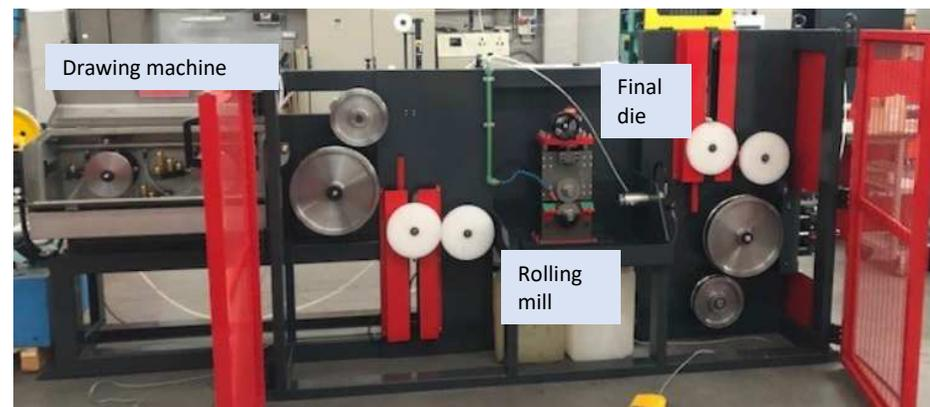
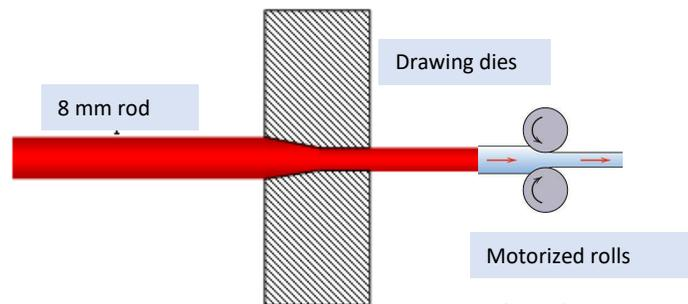

Enamelling Process

Second enamelling process

■ DRAWING AND ANNEALING BY THERMAL OVEN m/min

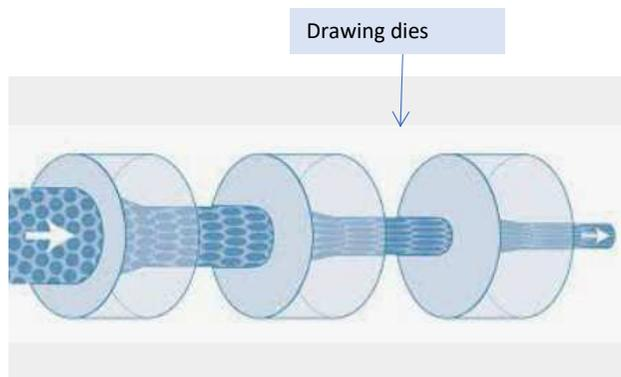

Enamelling Process

Second enamelling process

Horizontal oven



Round wire 0,05 mm up to 3,5 mm



Manual double spooler



Vertical oven

1mm up to strips 100 mm²

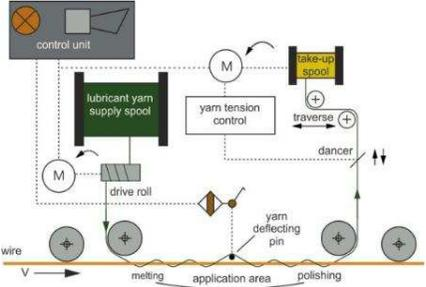

External lubricant

II. Existing standards to qualify magnet wire. Focus: Mechanical and dielectrical tests

Sonia DJENNAD – LSEE Université d'Artois

- History of enamels
- Enamelling Process
- HI-ECOWIRE Process
- Magnet wire properties
- Tests methods and standards
 - Aging (Thermal, Electrical, Mechanical, Environmental)
 - Electrical tests (Partial Discharge inception voltage, Breakdown voltage, dissipation factor)
 - Thermal tests (thermal index, heat shock, cut through)
 - Mechanical tests (peel test, flexibility)
- Questions/answers

HI-ECOWIRE Process

Horizontal oven for sol/gel insulation

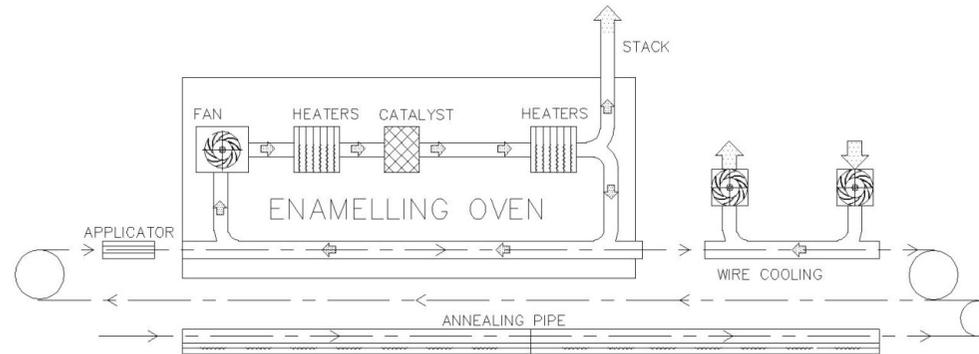

0,3 mm up to strips 10 mm²

Automatic double spooler

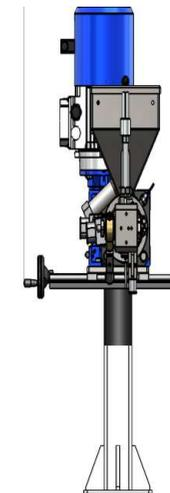
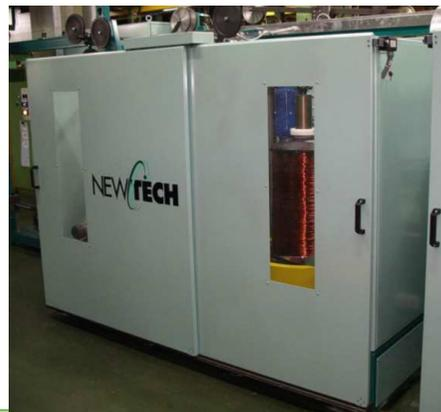

Extrusion equipment



HI-ECOWIRE Process

PROCESS at LSEE (Université d'Artois)

Applicator device

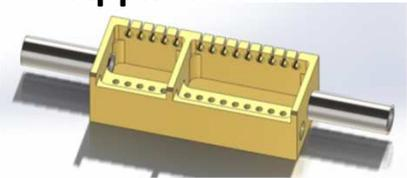

Die

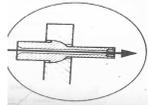

Enamelling oven



Cooling area

Standard enamelling machine

One pass of extrusion

Extrusion



II. Existing standards to qualify magnet wire. Focus: Mechanical and dielectrical tests (Sonia DJENNAD – LSEE Université d'Artois)

- History of enamels
- Enamelling Process
- HI-ECOWIRE Process
- Magnet wire properties
- Tests methods and standards
 - Aging (Thermal, Electrical, Mechanical, Environmental)
 - Electrical tests (Partial Discharge inception voltage, Breakdown voltage, dissipation factor)
 - Thermal tests (thermal index, heat shock, cut through)
 - Mechanical tests (Peel test, flexibility)
- Questions/answers

Magnet wire Properties

■ METHODS

- IEC 60172 (EUROPE), IEC 60851 (Parts 1 to 6)
- NEMA MW 1000 C (USA)

■ SPECIFICATIONS

- IEC 60317-26 : classe 200
- IEC 60317-57 : classe 220
- IEC 60317-59 : classe 240
- UL underwriter laboratories (AMERICAN)

■ Aspect (smooth)/Mechanical/Thermal/Dielectric/Chemical



Magnet wire Properties



Low voltage machines (<700V) are almost all built with standard or reinforced enamelled wire (type 1, qualification and tests by IEC 60034-18-1-41).

- The inter-turn insulation is obtained by a thin organic insulating layer which covers the copper wire.
- The insulation between the coils and the metal parts, generally called "slot insulation" is also made with films derived from organic chemistry. This set is sometimes impregnated by an organic varnish too.

The Electrical Insulation System (EIS) of large machines that operate under high voltages are generally built with non-organic materials (glass fabrics, mica, etc.) and epoxy resins (Type 2, qualifications and tests by IEC 60034-18-1-42).

All these materials are polymers

II. Existing standards to qualify magnet wire. Focus: Mechanical and dielectrical tests

Sonia DJENNAD – LSEE, Université d'Artois

- History of enamels
- Enamelling Process
- HI-ECOWIRE Process
- Magnet wire properties
- Tests methods and standards
 - Aging (Thermal, Electrical, Mechanical, Environmental)
 - Electrical tests (Partial Discharge inception voltage, Breakdown voltage, dissipation factor)
 - Thermal tests (thermal index, heat shock, cut through)
 - Mechanical tests (Peel test, flexibility)
- Questions/answers

Tests methods and standard: Aging

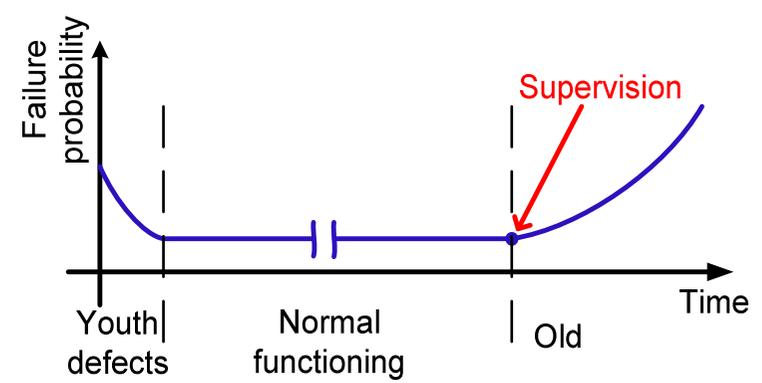
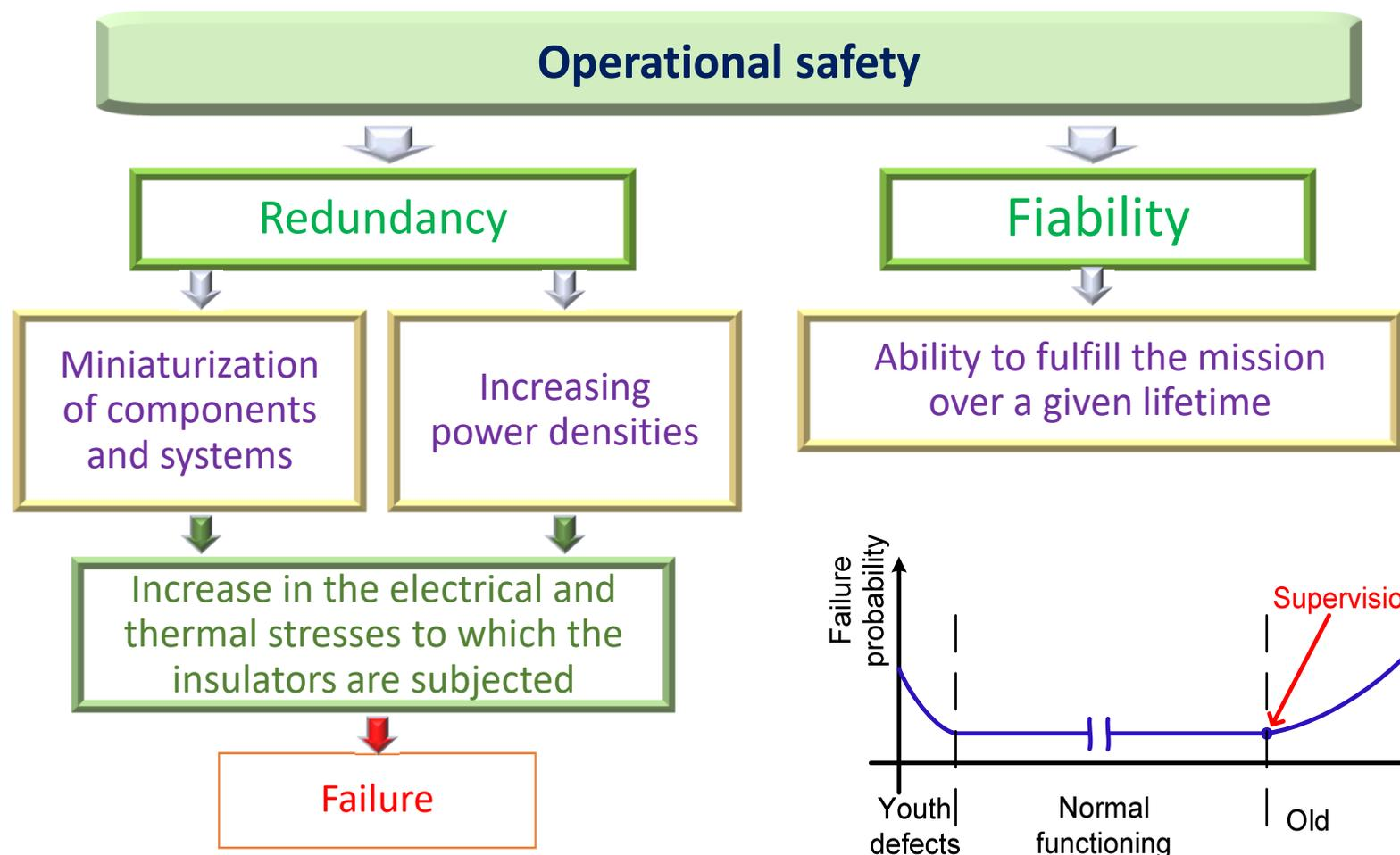

Tests methods and standard: Aging

The aging of a solid, liquid or gaseous insulation is a slow and irreversible degradation, occurring during its normal use, leading to a loss of its functional properties.

Physical aging

It is due to cracking, absorption phenomena (moisture, solvents) or desorption (migration of additives or residues), appearance of heterogeneities by migration of components. The spatial configuration of the macromolecules or the composition of the material are affected, but the chemical structure is not altered.

Chemical aging

It concerns any phenomenon involving an irreversible chemical modification of the material. The chemical reactions, induced by thermal degradation, and which can occur simultaneously are:

- Oxidation
- Crosslinking
- Depolymerization
- Statistical cut of the macromolecular skeleton,
- Formation of by-products.

Tests methods and standard: Aging

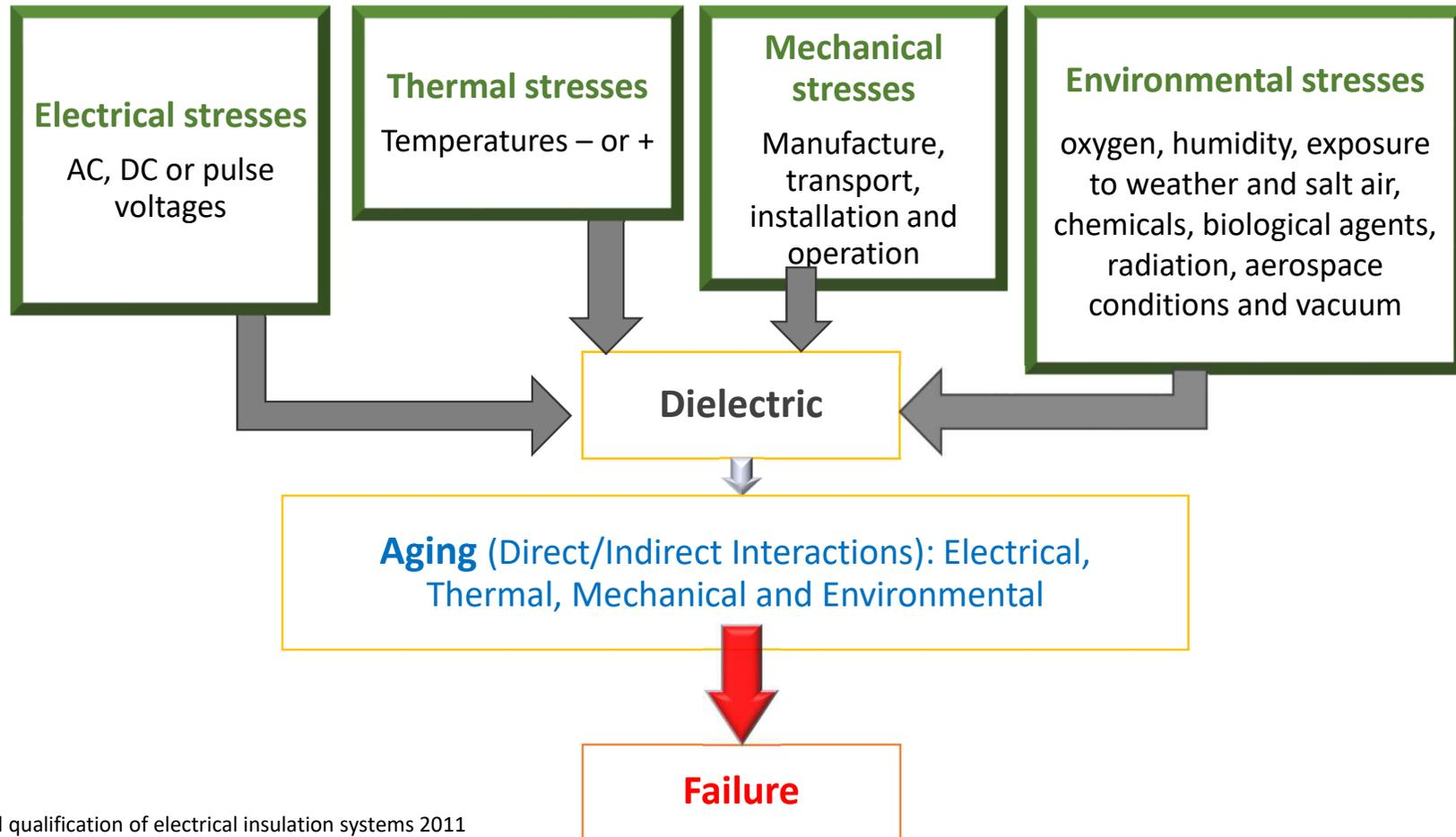

Tests methods and standard: Aging

- Natural aging is very slow. In order to be able to predict the behavior of the insulation over short periods of time, accelerated aging is carried out.
- Acceleration of aging (according to IEC 60505):
 - by increasing the stress level.
 - by increasing the frequency
 - by increasing the repetition rate.

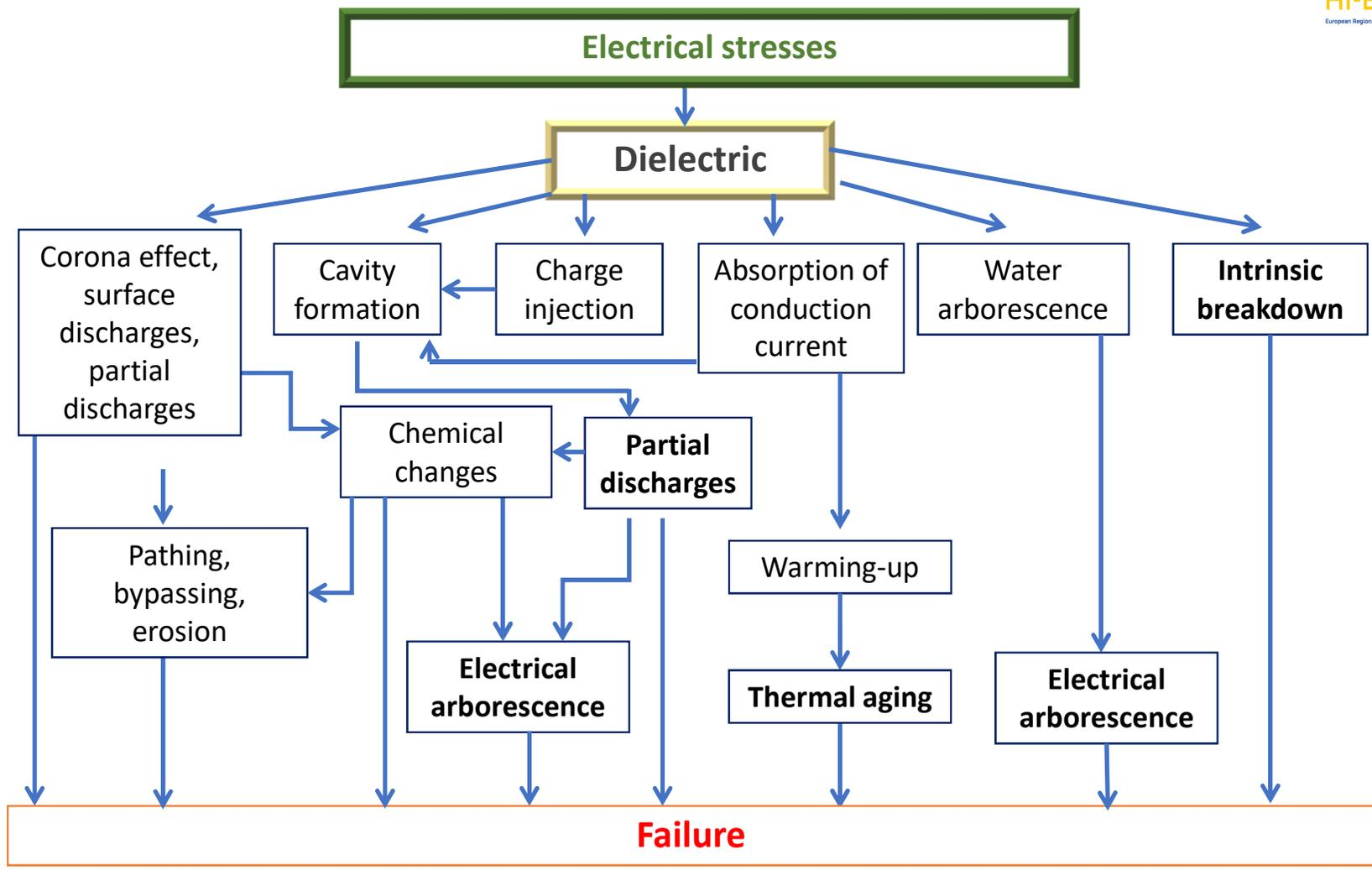

Tests methods and standard: Electrical Aging

More stringent constraints on the windings



Possibility to have partial discharge (PD) at the working voltage

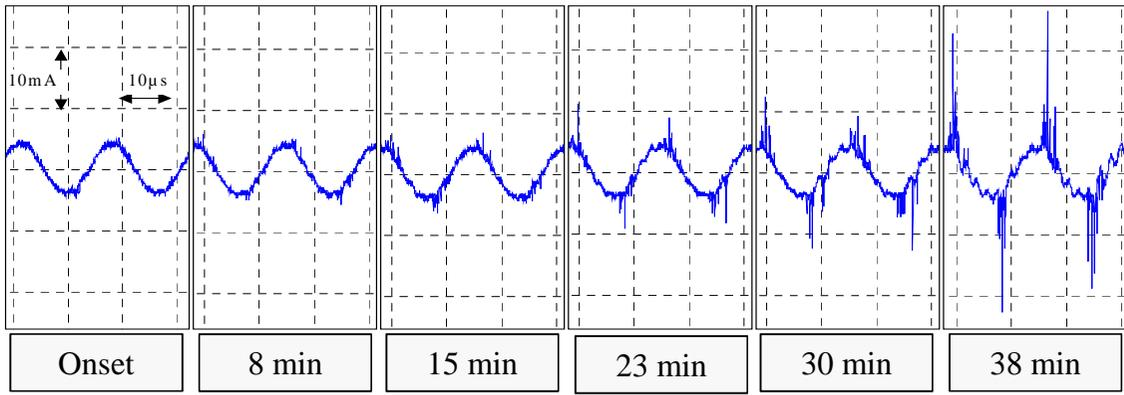

Fault

Applied voltage: 800V, 30 kHz

Tests methods and standard: Thermal Aging

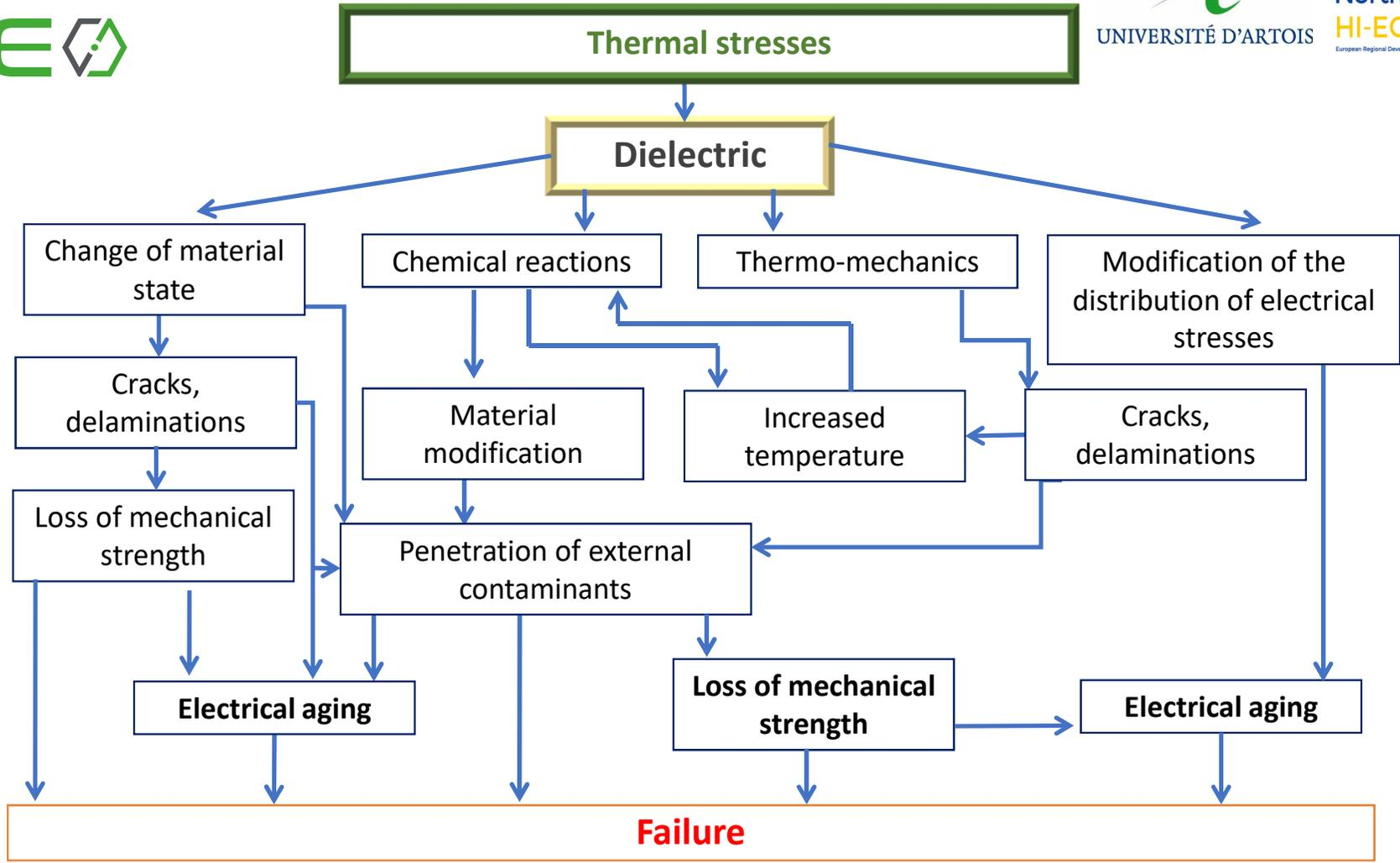

IEC 60505, Evaluation and qualification of electrical insulation systems, 2011.

Tests methods and standard: Thermal aging

Self-bonding twisted pairs thermal aging

a) New twisted pair



b) After 1 day at 280 °C



c) After 2 days at 280 °C



d) After 5 days at 280 °C



e) After 7 days à 280 °C



f) After 8 days at 280 °C



Tests methods and standard: Mechanical aging

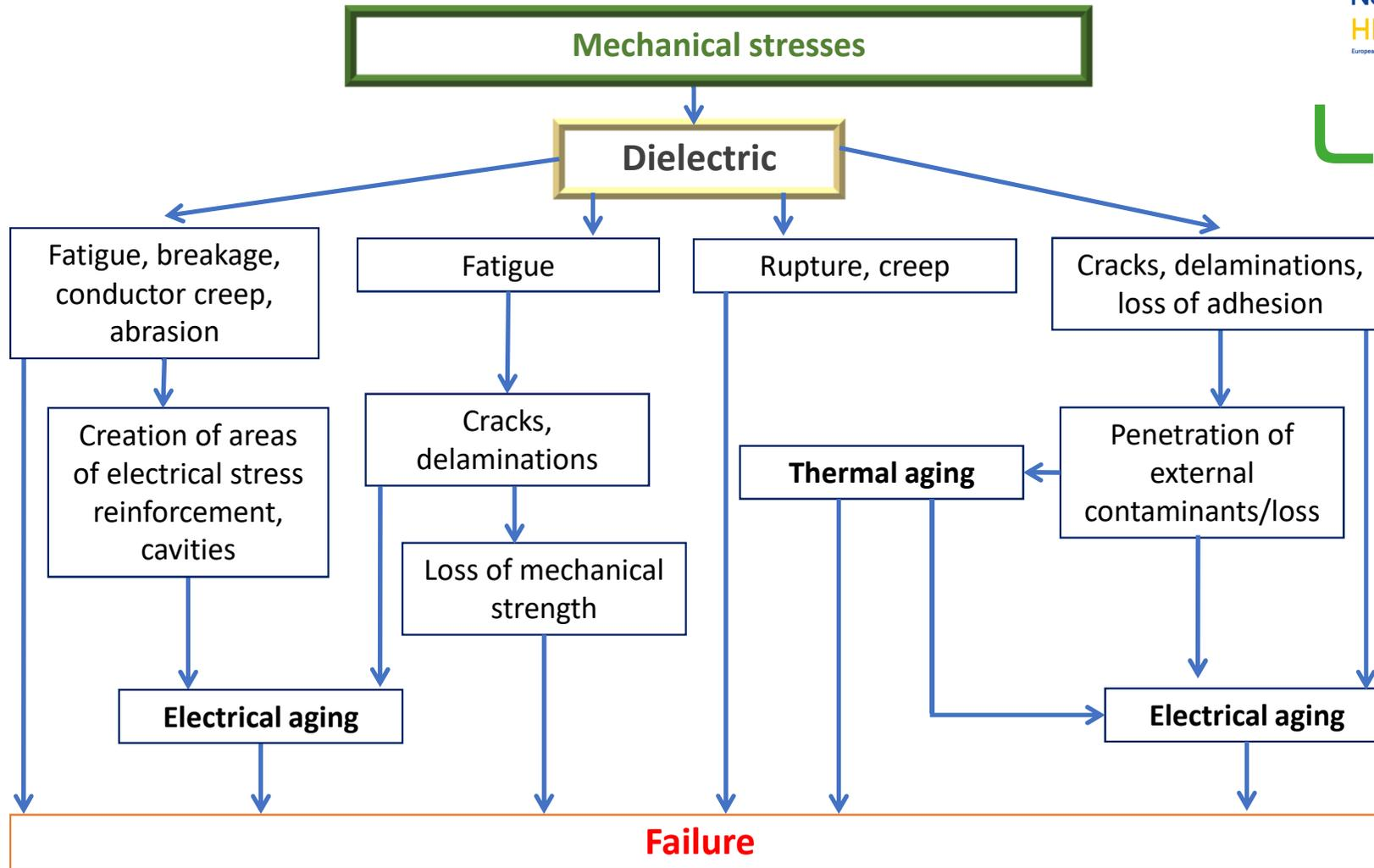

Tests methods and standard: Mechanical aging

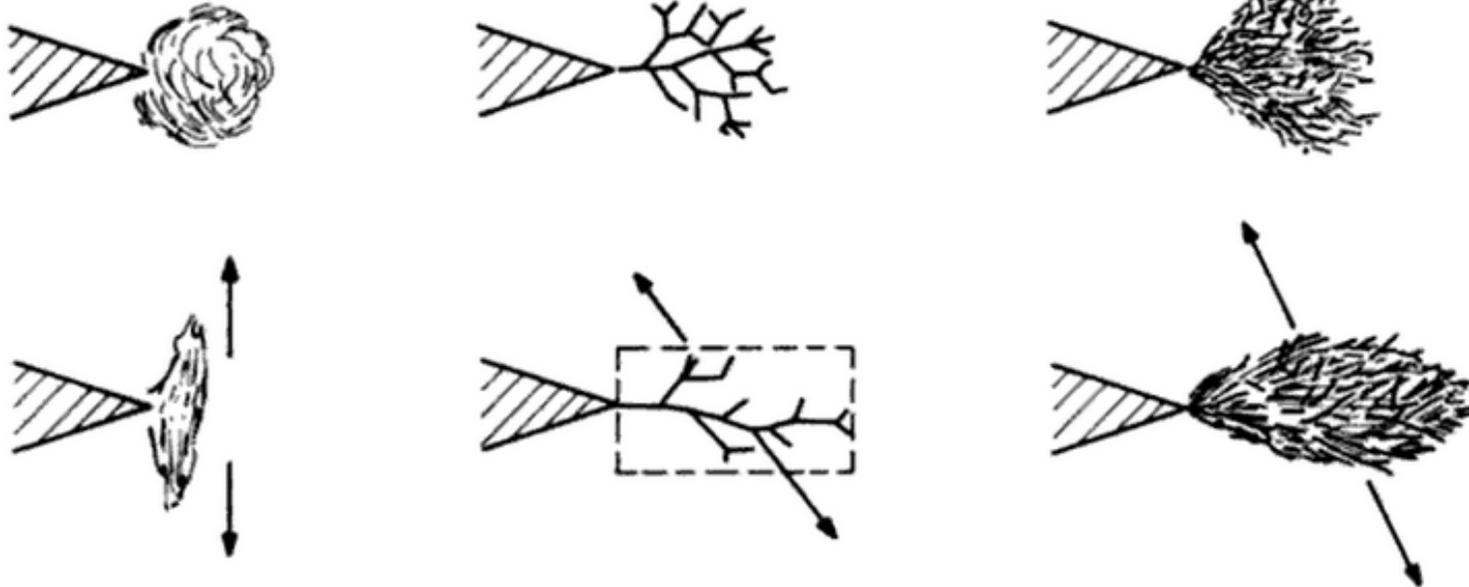

Schematic representation of the behavior of trees in materials subjected to tensile stresses (indicated by arrows)

Tests methods and standard: Environmental aging

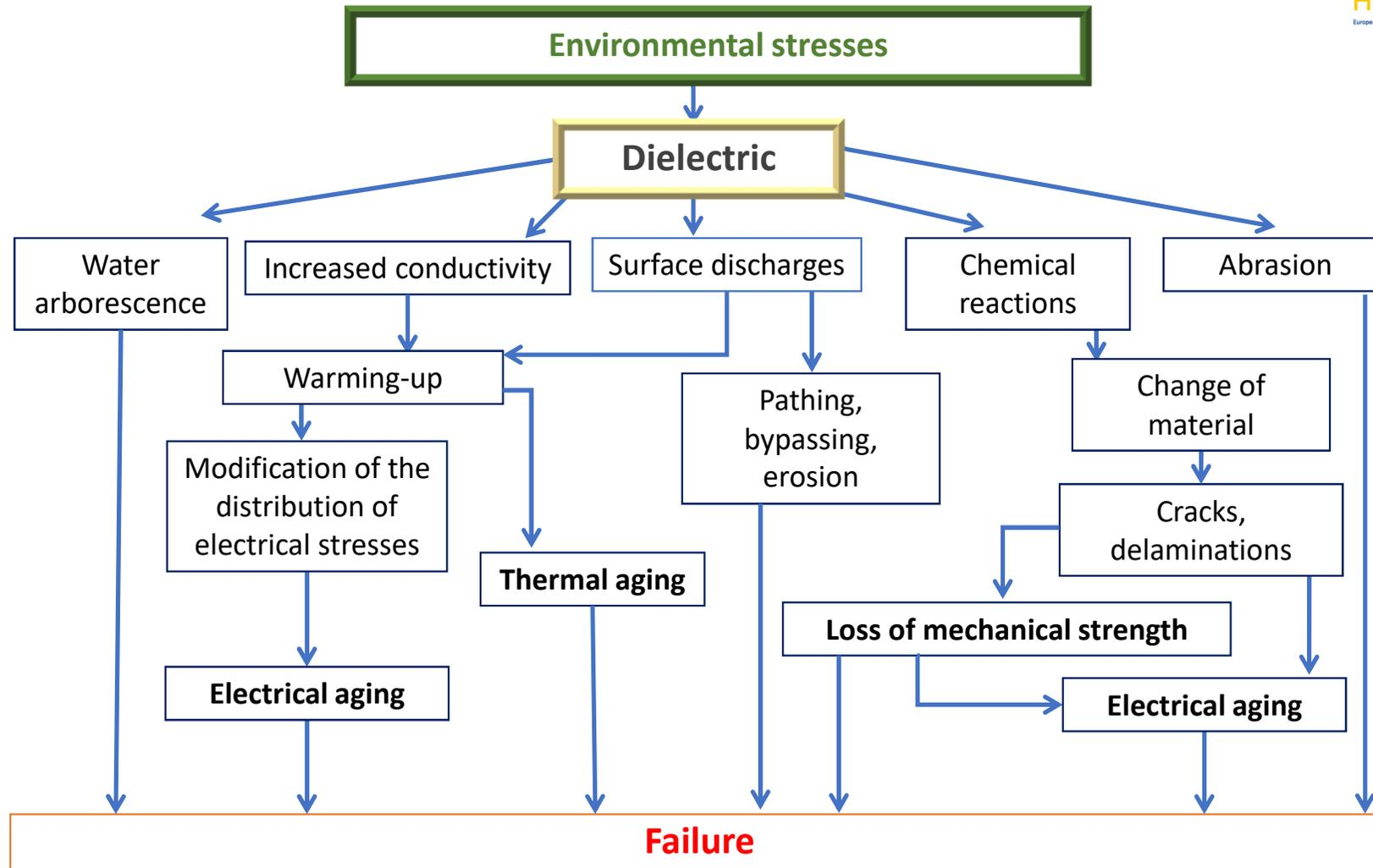

Tests methods and standard: Aging

Interests:

- Know the lifespan of an insulating material under stress
- Predict its behavior under constraint(s) → Predict failure
- Develop new materials
- Linked to:
 - Power increasing
 - Miniaturization of systems
 - Financial cost
 - Reliability.

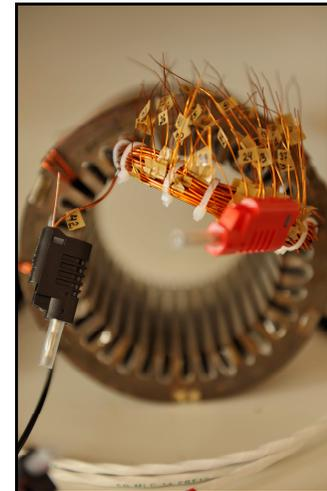

II. Existing standards to qualify magnet wire. Focus: Mechanical and dielectrical tests (Sonia DJENNAD – LSEE Université d’Artois)

- History of enamels
- Enamelling Process
- HI-ECOWIRE Process
- Magnet wire properties
- Tests methods and standards
 - Aging (Thermal, Electrical, Mechanical, Environmental)
 - Electrical tests (Partial Discharge inception voltage, Breakdown voltage, dissipation factor)
 - Thermal tests (thermal index, heat shock, cut through)
 - Mechanical tests (Peel test, flexibility)
- Questions/answers

Tests methods and standard: Electrical tests

Partial Discharge Inception Voltage

A partial discharge is a brief electrical phenomenon resulting from avalanches in the gas located in the vacuoles of the EIS or on its surface.

The threshold voltage for the appearance of partial discharges called PDIV (Partial Discharge Inception Voltage): is the voltage from which one begins to observe a recurrence of discharges

As a rule, partial discharges are a consequence of local concentrations of electrical stress.

Test standard: IEC 60270, IEC 60034-18-1-41.

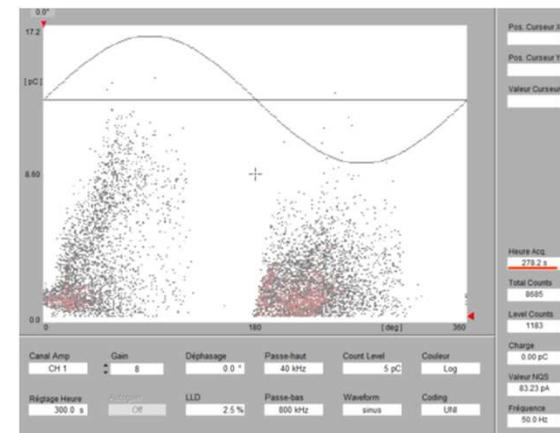
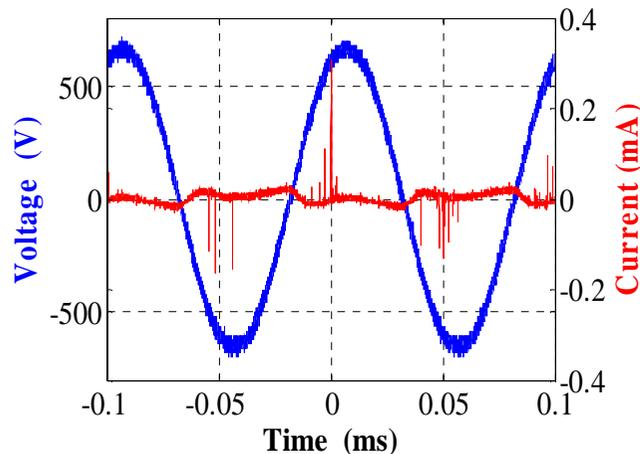

Tests methods and standard: Electrical tests

Partial Discharge Inception Voltage

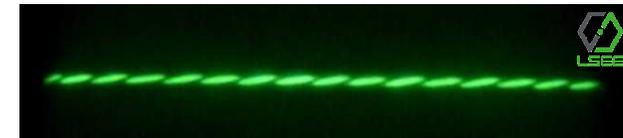
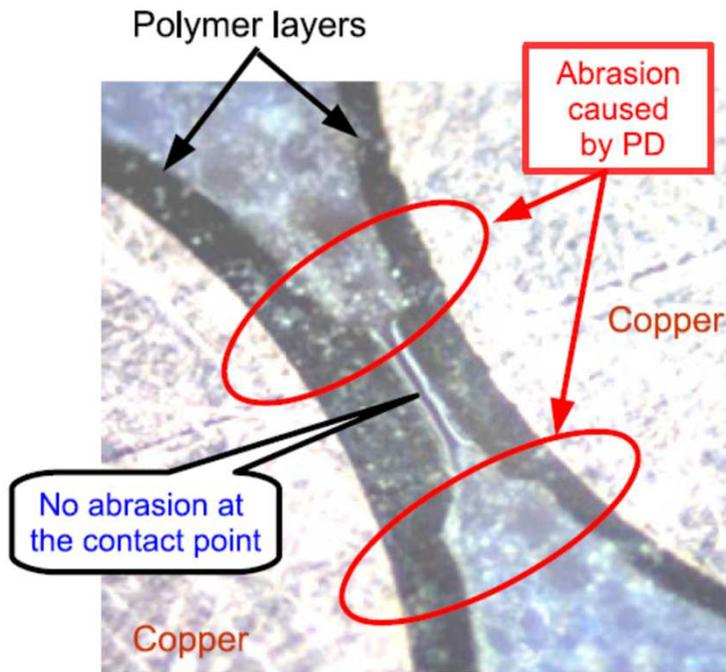

Partial discharges activity on twisted pair.

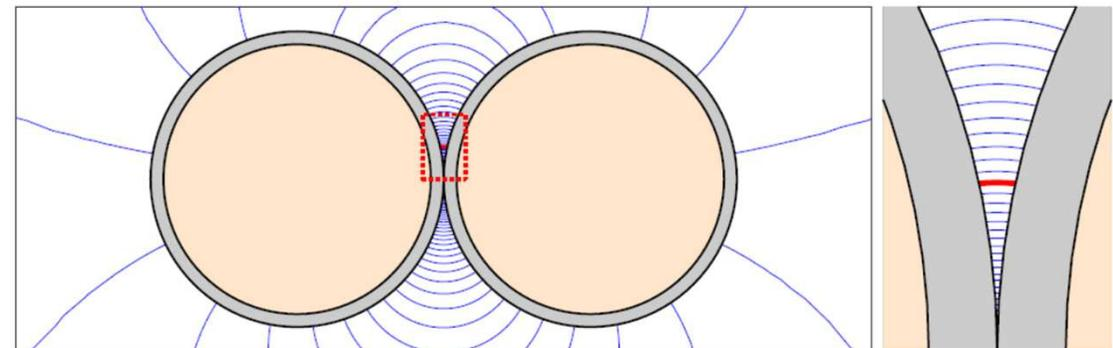

Field lines distribution in the air surrounding a pair of twisted wires. Zoomed-in view of the conductors (left). Zoomed-in view of the critical field line (right).

D. Roger et al. A Proposition for Improving the Design of Motor Windings for Low-Pressure Environment, Transactions On Industry Applications, Volume: 56, Issue: 3, May-June 2020.

G. Parent et al.: Determination of pdiv and location of pds by means of Paschen's theory and FEM, IEEE Transactions on Magnetics, Volume: 55, Issue: 6, June 2019.

Tests methods and standard: Electrical tests

Partial Discharge Inception Voltage : Paschen law

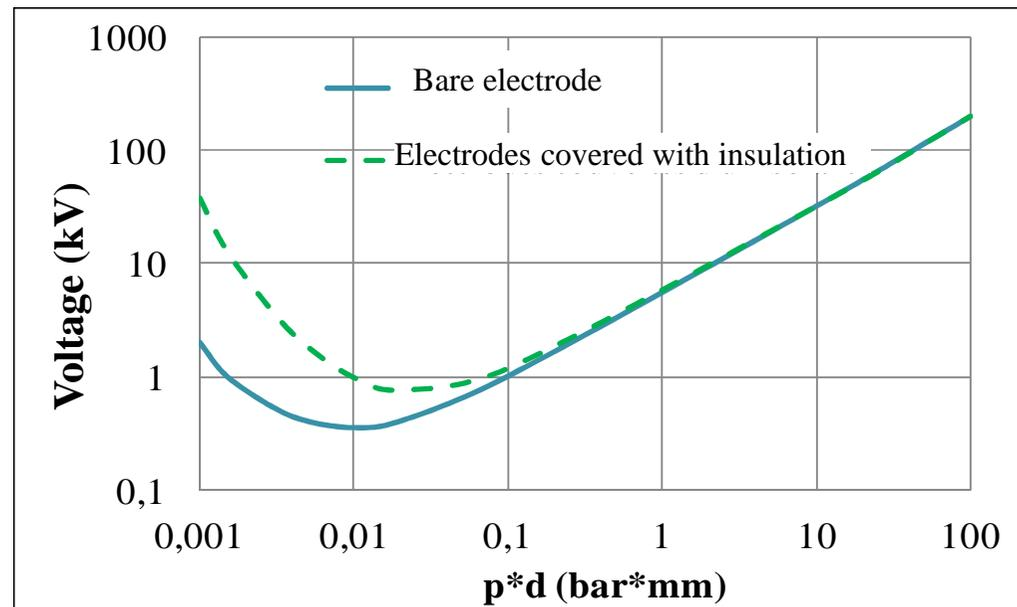
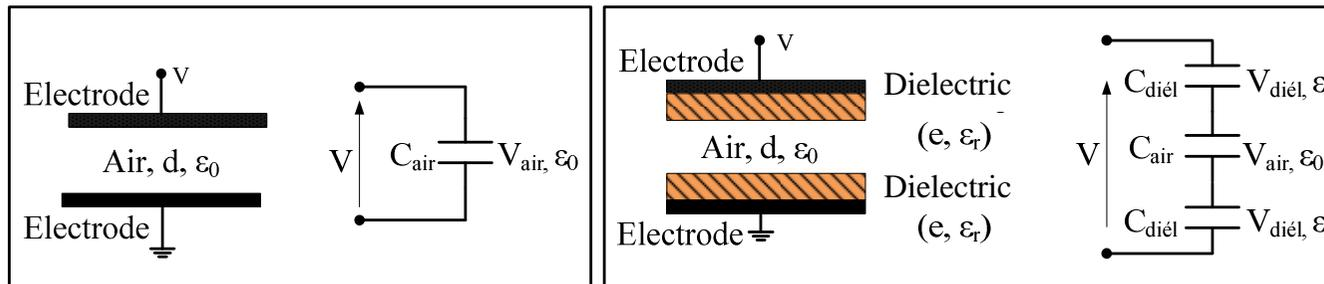

Paschen's curve (air, T=20 °C, p=1 bar)

Tests methods and standard: Electrical tests

Partial Discharge Inception Voltage

Interest of the measurement:

Detect possible faults in the electrical insulation system (EIS) → Assess the service life of the Electrical Insulation System (EIS).

Role of the measurement system:

- Extract fast signals of very low amplitude (PD signatures).
- Attenuate signals due to the response of the device under test to generator excitation.

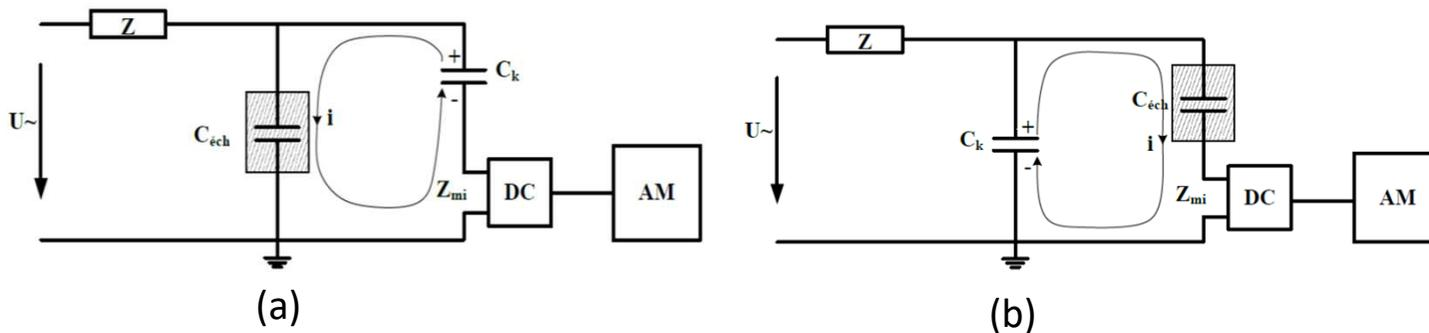

Measurement circuit with the sample in parallel (a) and in series (b) with the measurement system according to IEC 60270



Tests methods and standard: Electrical tests

Breakdown Voltage

Standard: IEC 60851-5.4 and IEC 60243-1

Samples : 5 twisted pairs

For wire diameter from 0.10 mm up to 2.50 mm (HI-ECOWIRE): the test voltage shall be applied between the two conductors of the specimens at a rate of 100V/s for breakdown voltage from 500 V up to 2500V, or 500V/s for higher breakdown voltage.



Tests methods and standard: Electrical tests

Dissipation factor ($\text{tg}\delta$)

Standard: IEC 60851-5, IEC 62631-1.

Use 1 sample :

- A length of straight wire of about 150mm is coated with a conductive layer, for example by coating the wire with graphite. The specimen will be dried for 30 minutes at 100°C in a circulating air oven.

OR

- A sample of wire shall be bent into a U-shape, and lowered into a metal bath.

The sample is connected to the impedance measuring device. It will be brought to a specified test temperature.

$\text{Tg}\delta$, the frequency and the test temperature must be noted

Generally, the values of $\text{Tg}\delta$ are related to the temperature index

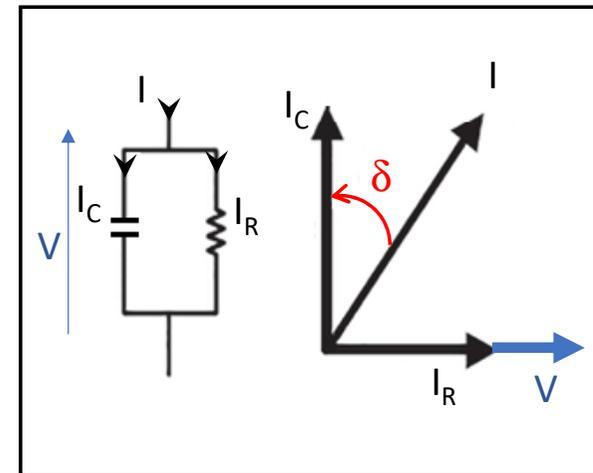
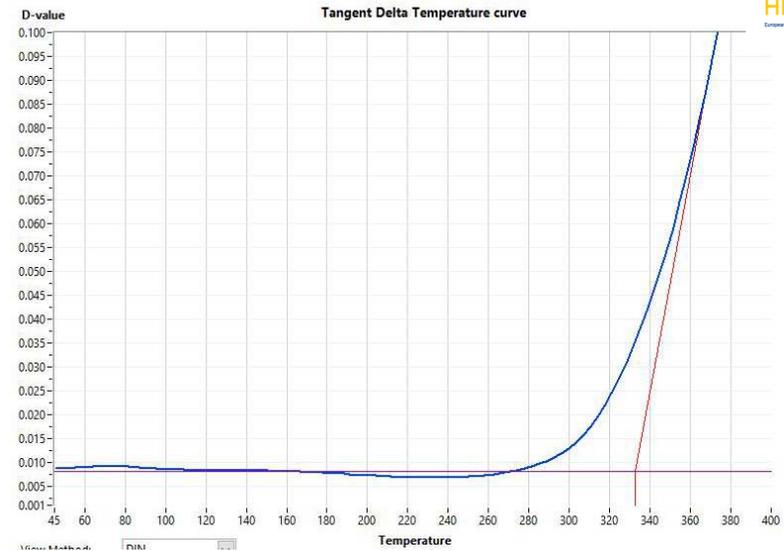

II. Existing standards to qualify magnet wire. Focus: Mechanical and dielectrical tests

Sonia DJENNAD – LSEE Université d'Artois

- History of enamels
- Enamelling Process
- HI-ECOWIRE Process
- Magnet wire properties
- Tests methods and standards
 - Aging (Thermal, Electrical, Mechanical, Environmental)
 - Electrical tests (Partial Discharge inception voltage, Breakdown voltage, dissipation factor)
 - Thermal tests (thermal index, heat shock, cut through)
 - Mechanical tests (Peel test, flexibility)
- Questions/answers

Tests methods and standard: Thermal tests

Thermal index

The thermal index (TI) is defined in IEC 60270 as the temperature, expressed in degrees Celsius, for which the time taken to reach a specific point in the degradation process is 20,000 hours. In the particular case of enamelled wire, the limit point which characterizes the estimated lifetime, corresponds to the destruction of 50% of the aged samples after a proof test under a specific voltage during 10 seconds.

This concept is based on Arrhenius equation that indicates the existence of a linear relationship between the logarithm of the time required to cause a predetermined physicochemical change and the inverse of the absolute temperature.

$$T_f = T_{f1} \exp \left[\frac{E_a}{R} \left(\frac{1}{T} - \frac{1}{T_1} \right) \right]$$

E_a : activation energy of material [J/mol]

R : universal gas constant, $R=8.314 \text{ J}\cdot\text{mol}^{-1}\cdot\text{K}^{-1}$

T and T_1 : températures (°K)

T_f and T_{f1} : Time (h)

Arrhenius extrapolation curve for a PAI-PEI classical wire (TI 200°C)

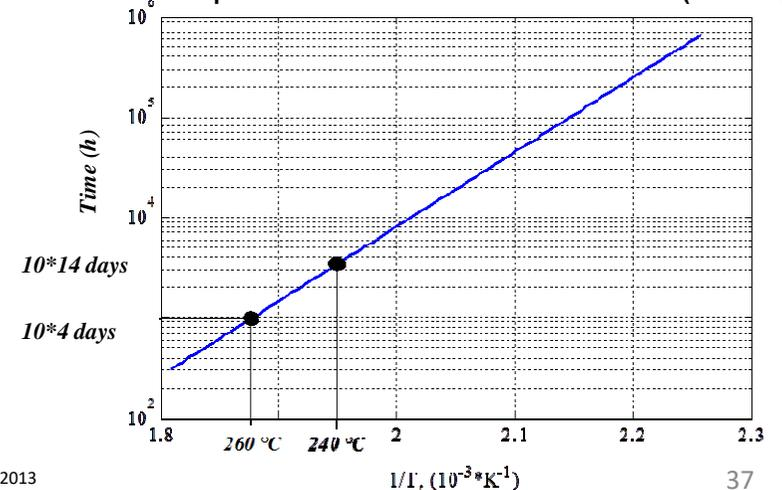

Tests methods and standard: Thermal tests

Thermal index

- Preparation of the samples: 11 Twisted pairs in accordance with the standard IEC 60851-5 or IEC 60172

Load and number of turns of specimens

Wire diameter (mm)		Load (N)	Turns number
From	to		
0,1	0,25	0,85	33
0,25	0,35	1,7	23
0,35	0,5	3,4	16
0,5	0,75	7	12
0,75	1,05	13,5	8
1,05	1,5	27	6
1,5	2,15	54	4
2,15	3,5	108	3

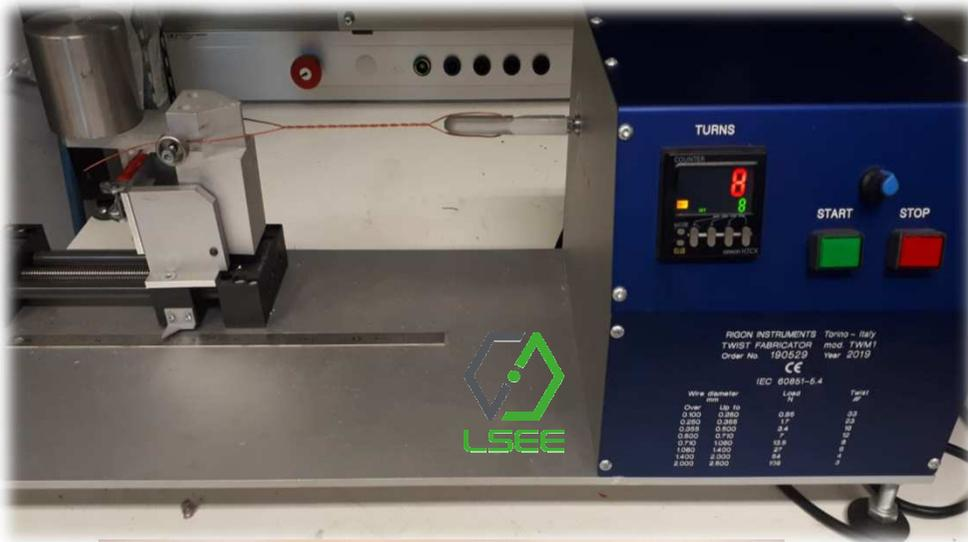

Tests methods and standard: Thermal tests

Thermal index

- IEC 60172:
 - 10 cycles of aging
 - 3 temperatures
 - Temperatures and times consistent with thermal endurance graph
 - A maximum difference of 20°C between two test temperatures

Aging temperature (°C)	Insulation index of the wire (°C)						
	105-109	120-130	150-159	180-189	200-209	220-229	240-249
Thermal cycles duration (days)							
320							1
310							2
300						1	4
290						2	7
280					1	4	14
270					2	7	28
260				1	4	14	49
250				2	7	28	
240				4	14	49	
230			1	7	28		
220			2	14	49		
210		1	4	28			
200		2	7	49			
190	1	4	14				
180	2	7	28				
170	4	14	49				
160	7	28					
150	14	49					
140	28						
130	49						

Tests methods and standard: Thermal tests

Heat shock

Standard: IEC 60851-6

Samples : 3 for round wires according to IEC 60851-3

Heat shock test measures the capability to resist cracking of the insulation after physical stressing (turns on 1, 2 or 3D) and after a rapid temperature change.

Baking for 30 mn at a temperature 20°C above the thermal class.

Binocular observation if cracks.

Tests methods and standard: Thermal tests

Cut through (thermoplasticity)

- Standard : IEC 60851-3
- The thermoplasticity temperature is an indicator of insulation decomposition. It is expressed by the temperature at which a short circuit appears between two pieces of enameled wire crossing each other at right angles.
- The central point shall be under the piston.
- After a heating period, a specified load shall be applied by means of the piston.
- The warm-up is started and the device will signal when there is a short circuit.
- The temperature is taken at this time.
- Number of tests: 3.



II. Existing standards to qualify magnet wire. Focus: Mechanical and dielectrical tests

Sonia DJENNAD – LSEE Université d'Artois

- History of enamels
- Enamelling Process
- HI-ECOWIRE Process
- Magnet wire properties
- Tests methods and standards
 - Aging (Thermal, Electrical, Mechanical, Environmental)
 - Electrical tests (Partial Discharge inception voltage, Breakdown voltage, dissipation factor)
 - Thermal tests (thermal index, heat shock, cut through)
 - Mechanical tests (Peel test, flexibility)
- Questions/answers

Tests methods and standard: Mechanical tests

Peel test

- Standard : IEC 60851-3
- Removal of the insulation on two opposite sides of the wire (under/over)
- Device rotation under constant speed specified in the standard. The number of laps is counted to reach the controlled loss of grip on touchdown.
- Verification of detachment under the fingers.



Peel test < 100



>240

Tests methods and standard: Mechanical tests

Flexibility

- Standard : IEC 60851-3.
- Enamelled wire which is subjected to windings (10 turns) around its own diameter (1D).
- Binocular observations.
- Sample classified as good, if there are no cracks

Flexibility 1D for diameter < 1mm prestretch of the wire

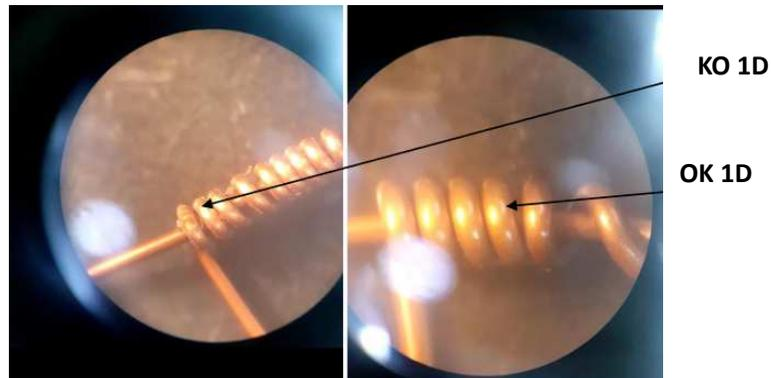

Accelerated aging = Aging in service??

- Aging = long-term measures
- Use of accelerated tests (constraint(s), frequency, etc.)
- Realistic?
- Difficult analysis, not necessarily a correlation between dielectric and chemical properties (limits of Arrhenius law)
- Following standards – enough?

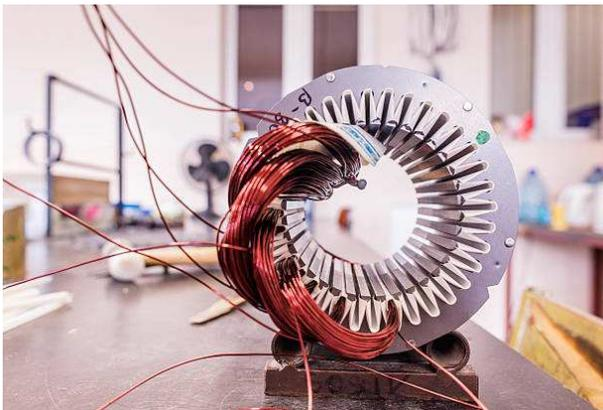

Question ?

<https://www.nweurope.eu/projects/project-search/hi-ecowire-high-quality-eco-efficient-magnet-wire/>

EMAIL: hi-ecowire@materianova.be



Existing standards to qualify magnet wire. Focus: Mechanical and Dielectrical tests