



**HAL**  
open science

# Interpretation of Eccentricity of an Enameled Wire by Capacitance Measurements

Sonia Ait-Amar, Abdoulay Koita, Gabriel Vélú

► **To cite this version:**

Sonia Ait-Amar, Abdoulay Koita, Gabriel Vélú. Interpretation of Eccentricity of an Enameled Wire by Capacitance Measurements. *Energies*, 2022, 15 (8), pp.2802. 10.3390/en15082802 . hal-04150203

**HAL Id: hal-04150203**

**<https://univ-artois.hal.science/hal-04150203>**

Submitted on 19 Nov 2023

**HAL** is a multi-disciplinary open access archive for the deposit and dissemination of scientific research documents, whether they are published or not. The documents may come from teaching and research institutions in France or abroad, or from public or private research centers.

L'archive ouverte pluridisciplinaire **HAL**, est destinée au dépôt et à la diffusion de documents scientifiques de niveau recherche, publiés ou non, émanant des établissements d'enseignement et de recherche français ou étrangers, des laboratoires publics ou privés.

1 Article

# 2 Interpretation of eccentricity of an enameled wire by capaci- 3 tance measurements

4 Sonia Ait-Amar\*, Abdoulay Koita and Gabriel Vélu

5 Univ. Artois, UR 4025, Laboratoire Systèmes Electrotechniques et Environnement (LSEE), Béthune, F-62400,  
6 France

7 \* Correspondence: [sonia.aitamar@univ-artois.fr](mailto:sonia.aitamar@univ-artois.fr)

8 **Abstract:** Actually, there are systems dedicated to measuring the eccentricity of enameled wires  
9 based on optical and electromagnetic phenomena. However, these methods are limited by the na-  
10 ture of the insulation and the conductor. The proposed solution consists of checking the wire eccen-  
11 tricity by an electrical measurement. Since it is a conductor on which an insulator is placed, the idea  
12 consists to form a capacitor and its capacitance will be measured in order to deduce the insulation  
13 thickness.

14 **Keywords:** dielectric; enameled wire; capacitance, eccentricity.

15

## 16 1. Introduction

17 The conventional magnet wires used to make the windings of electrical machines are  
18 achieved using polymeric insulation coating on the copper conductor called enameled  
19 wire. The classic enameling process consists of applying very thin layers of polymeric  
20 varnish to the copper wire. Multipass process is used to obtain an increase of diameter  
21 according to the specifications of international standards [1-3].

**Citation:** Lastname, F.; Lastname, F22  
Lastname, F. Title. *Energies* 2021, 14,23  
x. <https://doi.org/10.3390/xxxxx> 24  
25  
Academic Editor: Firstname Last- 26  
name 27  
28

The manufacturing process is well controlled. The viscosity of the varnish is opti-  
mized. When the wire passes through a felt applicator, it takes calibrated drops of varnish  
in the wire by the pressure of the varnish. It is calibrated in thickness by dies or by a  
metered deposit between felts. The copper conductor is then well centered with respect  
to the die. Dielectric tests [4-5] are carried out on standardized twisted specimens [6] to  
check the wire characteristics, such as copper centricity.

Received: date 29  
Accepted: date 30  
Published: date 31  
32

**Publisher's Note:** MDPI stays neu- 32  
tral with regard to jurisdictional 33  
claims in published maps and institu- 34  
tional affiliations. 35  
36  
37  
38



**Copyright:** © 2021 by the author 39  
Submitted for possible open access 40  
publication under the terms and 41  
conditions of the Creative Commons 42  
Attribution (CC BY) license 43  
(<https://creativecommons.org/licenses/by/4.0/>). 44

enameled wire concentricity is a parameter that intervenes in the lifespan of the windings of the electric machines.

The article proposes the study of a device for measuring the eccentricity of enameled wire on a continuous line. It exploits capacitance measurements to determine the thickness of the wire insulation. When the copper conductor is centered in the enamel, the insulation thickness should be the same all around and all along the enameled wire. Differential mode measurements compare the thicknesses by electrical measurements, that make it possible to deduce on the centering of the enameled wire. This original method is non-invasive and can be operated without stopping the enameled wire production line and without any modification on the conductor and for all insulated varnishes. Only pulleys require special machining for each wire diameter. Finally, this device has advantages over the optical [16-17], magnetic [17] or electromagnetic [16] systems already used, which cannot meet the needs of opaque or nanofilled varnishes and non-magnetic wires such as copper and aluminum.

## 2. Proposed Solution Principle

The proposed solution consists in verifying the eccentricity of the wire by an electrical measurement. Since this is a conductor with an insulator placed on it (Figure 1), the idea is to form a capacitor and measure its capacitance.

As a reminder, a capacitor is presented as two metal frames separated by an insulator (Figure 2). It is therefore sufficient to add a second conductor (metal frame) on the insulation of the wire to form a capacitor.

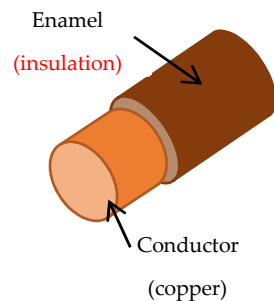

Figure 1. Illustration of an enameled wire.

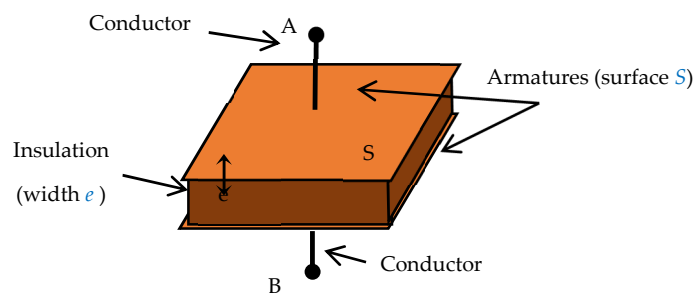

Figure 2. Representation of a planar capacitor.

In order to respect the circular shape of the wire, a metal disc with a diameter of 0.1 m was used as the second reinforcement. On the outer edge a circular slot with a radius of  $0.5 \times 10^{-3}$  m was made, so that it could contain the enameled wire (figures 3 and 4). This creates a cylindrical capacitor, on the contact distance between the wire and the disc.

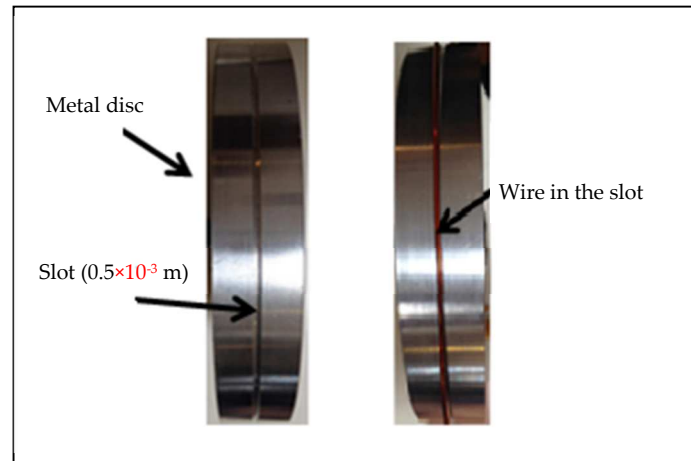

Figure 3. Disc with a slot on the outer edge.

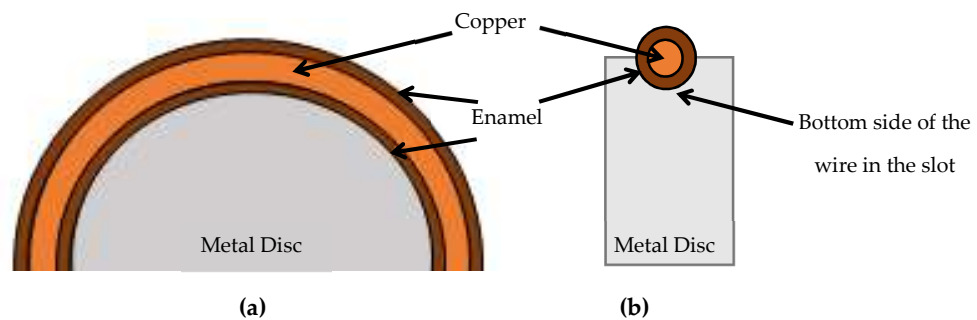

Figure 4. Frontal (a) and longitudinal (b) sections of the formed capacitor.

In the case of cylindrical coaxial capacitor of length  $l$ , the capacitance is given by [18]:

$$C = 2\pi\epsilon_0\epsilon_r \frac{l}{\log\left(\frac{R_2}{R_1}\right)} \quad (1)$$

With:

$$R_2 = R_1 + e \quad (2)$$

And:

$C$  : capacitance of the capacitor (F)

$\epsilon_0$ : permittivity of vacuum ( $8,854 \times 10^{-12}$  F.m<sup>-1</sup>)

$\epsilon_r$  : relative permittivity of the insulation (unitless)

$R_1$  : inner radius of the cylinder (m), this correspond to the wire radius in this configuration

$R_2$  : outer radius of the cylinder (m)

$e$  : Insulation thickness of the wire (m)

$l$  : Length of the cylinder (m), this is the arc formed by the contact between the disc and the wire.

As only the longitudinal half of the cylinder is considered, the half of the capacitance is determined. The relationship between the capacitance of the capacitor and the thickness of the dielectric in this case is given by equation:

$$C = \pi \epsilon_0 \epsilon_r \frac{l}{\log\left(1 + \frac{e}{R_1}\right)} \quad (3)$$

As the wire has a diameter of  $0.95 \times 10^{-3}$  m, the enamel thickness of about  $35 \times 10^{-6}$  m and the slot in the disc has a diameter of  $10^{-3}$  m, then the contact will only be made on half of the circumference of the wire (Figure 4. b).

To find out if the conductor is centered on both sides of the wire, two disks are used (Figure 5) to form two capacitors using the two halves of the wire circumference (up and bottom sides). This makes it possible to compare the thicknesses of the insulation on both sides of the wire, from the values of the capacities of the two capacitors.

The two coals will serve as contact for the two armatures, for each capacitor, and the contacts of the armature 1 will be recovered by clamps fixed on the stripped wire (without insulation).

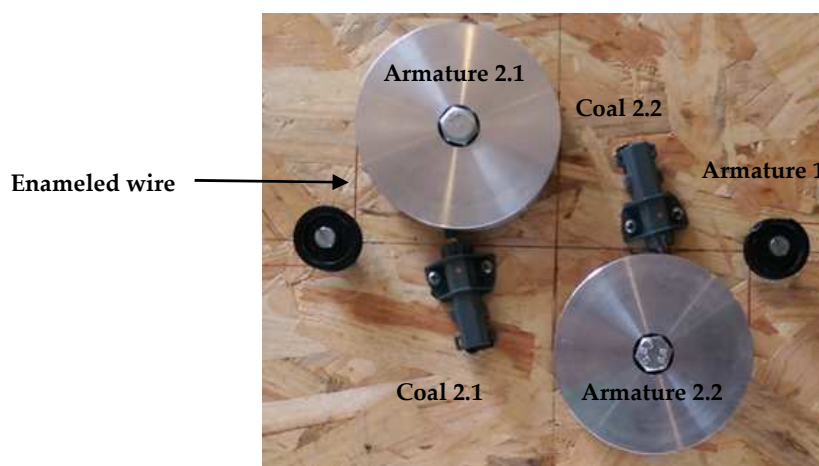

Figure 5. Synoptic system.

### 3. Experimental Setup

#### 3.1. Description:

The measuring device model consists of two parts. The first consists in creating a capacitor between a pulley and the conductor of the enameled wire (Figure 5). Two capacitors at opposite sides of the wire are achieved. The measurement of their capacitance will be carried out by an electronic card achieved as the second part (Figure 6). It converts differential capacitances in a proportional voltage signal.

Knowing that the capacitance is inversely proportional to the thickness of the dielectric (equation 1), it is possible to know the insulator thickness modification by capacitance monitoring measurement. To make this measurement, an electronic circuit that can include the capacitor and provide a quantity varying according to its capacitance was best suited. The diagram in Figure 7 shows the process of this measurement for two sides of the wire.

Firstly, an integrated circuit for precision timing NE555 is used as astable multivibrator mode for the two capacitors of our device. The principle of this circuit is to provide

163  
164  
165

a rectangular signal with a frequency that varies according to the passive components (resistors and capacitors) added to it.

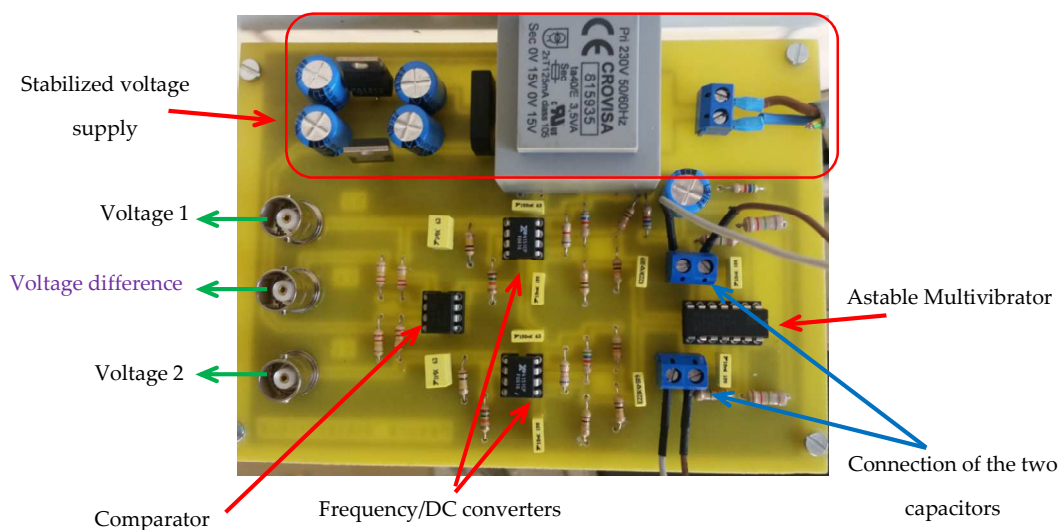

166  
167  
168  
169  
170  
171  
172  
173

Figure 6. Electronic card made for measurements

174  
175  
176  
177  
178  
179  
180

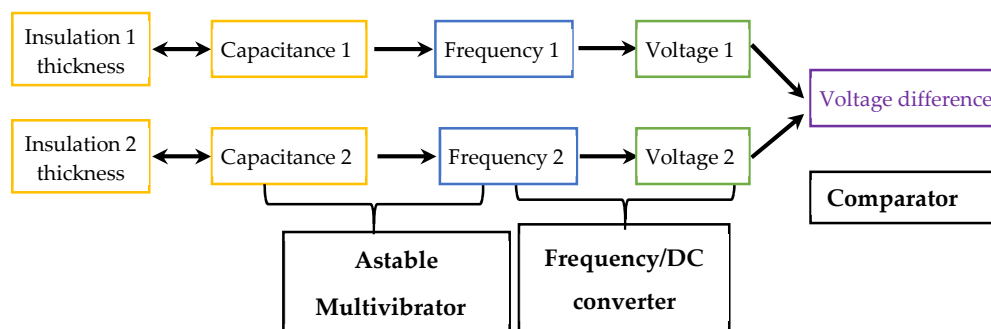

181

Figure 7. Illustration of the process measurement principle.

182  
183  
184  
185  
186  
187  
188  
189  
190  
191  
192  
193  
194  
195

To compare the two thicknesses, it suffices to compare the two frequencies. However, the comparison of frequencies seems delicate. Then, these frequencies are converted into direct voltages by using an XR4151 frequency/Dc converter. The voltage amplitudes vary as a function of these frequencies. If the thickness of the insulation is the same everywhere around the conductor and the measurement conditions are the same, then there is no reason for these voltages to be different.

To compare the two DC voltages from the converters, the LM833 operational amplifier is used as a comparator. It operates with high-gain bandwidth, and high slew rate and low noise. It is mounted as a difference amplifier (subtractor) with a gain of unity. Thereby, the measurement uses a differential mode that is much less sensitive to disturbances [19]. Also it does not depend on the type of varnish (more or less dielectric).

### 3.2. Validation

Two disks are used to form two capacitors using the two halves of the wire circumference. This makes it possible to compare the insulation thicknesses on both wire sides, based on the capacitance values. To compare the two thicknesses, it is sufficient to compare the two frequencies obtained by an adapted electronic circuit. If the thickness of the insulation is the same, everywhere around the conductor, and the measurement conditions are similar, the voltages are constant.

An electronic card has been produced. In order to validate its operation, measurement with variable capacitors were firstly carried out.

In Table 1 are shown the voltages measured at the output of the electronic card for the three possible cases of capacitance values. The voltages  $V_1$  and  $V_2$  depend on the thickness of dielectric 1 ( $C_1$ ) and dielectric 2 ( $C_2$ ) respectively. The difference of this two voltages (at the output of the comparator) is  $V_d$ . The difference in voltage when the capacitances values are different is observed.

**Table 1:** Voltage values at the outer of the electronic card

	$V_1(\text{V})$	$V_2(\text{V})$	$V_d(\text{V})$
$C_1 > C_2$	4,935	6,998	2,223
$C_1 < C_2$	5,277	2,920	-2,197
$C_1 = C_2$	2,390	2,327	0,089

## 4. Determination of Influencing Phenomena

The purpose of this part is to identify all the aspects (other than the thickness of the dielectric) that can contribute to the variation of the capacitances of the capacitors. An Agilent 4294A impedance analyzer is used to observe the capacitance in different situations. The measurement precision is 0,08% at  $10 \times 10^3$  Hz.

### 4.1. The mechanical constraint applied on the wire:

Different masses were used to apply mechanical constraint on the wire, when it is on the disc (Figure 8). Depending on the load, we can see the result in figure 9.

The results of this part lead to reflection on two points, namely, the pressure between the two armatures and the dielectric and the thickness of the dielectric.

Indeed, when the mass increases, the capacitance rises. But the latter can result in increased pressure or decreased thickness. It is difficult to make this distinction and to prevent the thickness from decreasing, the wire is kept as tight as possible. In addition, a very high mechanical constraint of the wire can modify the physicochemical properties of the dielectric, which consequently will involve considerable errors and would make false the results obtained.



245

Figure 8. Test bench for application on mechanical constraint.

246  
247  
248

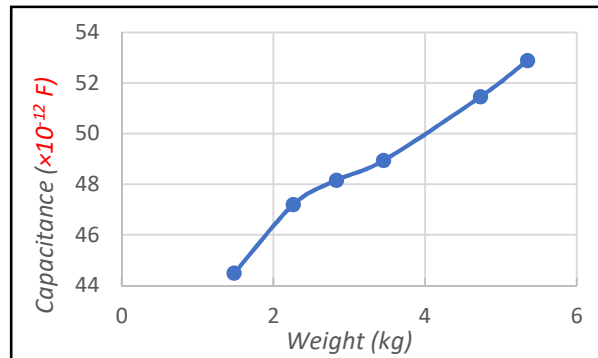

249  
250  
251  
252  
253

Figure 9. Evolution of the capacitance as a function of the weight applied on the wire.

#### 4.2. The length of the wire in contact with the disc:

254  
255  
256  
257  
258  
259

For the six fixtures in Figure 10, the same enameled wire ( $0.95 \times 10^{-3}$  m) was used with different occupancy lengths shown in red dots on the discs. In each case, a mass of 1,3 kg on each side allows the wire to be stretched as shown in Figure 11. The results are given in Table 2. The greater the contact length, the larger the capacitance.

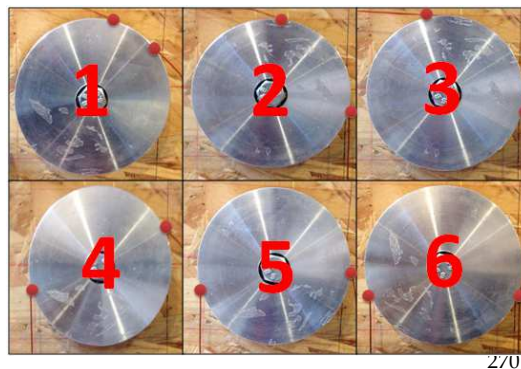

270

Figure 10. Assemblies for different lengths of wire on the disc.

271  
272



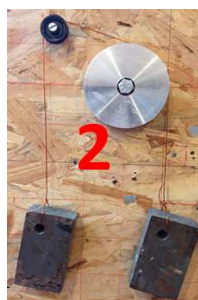

Figure 11. Assembly with occupancy of the quarter disc.

Table 2: Capacitance for different wire lengths

Assembly No.	Capacitance ( $\times 10^{-12}$ F)
1	17,7
2	29,60
3	35,40
4	57,83
5	63,50
6	70,55

#### 4. Results and Discussion

The Laboratoire Systèmes Electrotechniques et Environnement (LSEE), The Electro-technical Systems and Environment Laboratory (LSEE) is a university research laboratory which has a laboratory-scale enameling line. The effectiveness of this device is verified on an enamelled wire sample manufactured by this line, without worrying about the centering of the copper conductor. The insulation is based on classical PAI-PEI insulation of  $0.95 \times 10^{-3}$  m.

The configuration 2 has been used in order to have a maximum contact between the wire and the disc, making sure to have a minimum of stretched wire. If we assume that the difference in capacitance is due only to the difference in thicknesses, we can calculate the corresponding thicknesses, in order to analyze their values.

The voltages at the output of the electronic board were measured.  $V_1 = 3.171$  V,  $V_2 = 3.292$  V and  $V_i = 0.303$  V, are measured for the capacitors 1, 2 and the output of the comparator, respectively. They are converted into frequency according to the datasheet of the converter, namely:

$$f_{int} = 10^3 * \frac{V}{0,6} \quad (4)$$

Knowing the frequency makes possible to calculate the capacitance from the astable circuit component value.

Equation 3 allows us to return to the values of the thicknesses of the dielectrics of our two capacitors. As  $\frac{e}{R_1} \simeq 0$ , then:

$$C \approx \frac{\pi \epsilon_0 \epsilon_r l}{e} = \frac{\pi \epsilon_0 \epsilon_r l}{e} * R_1 \quad (5)$$

For the used system, the capacitance is:

$$C = \frac{\pi^2 \epsilon_0 \epsilon_r}{2 * e} * R_1 * (R_D - R_1 - e) \quad (6)$$

With :

C : capacitance of the capacitor (F)

$\epsilon_0$ : permittivity of vacuum ( $8,854 \times 10^{-12}$  F.m<sup>-1</sup>)  
 $\epsilon_r$ : relative permittivity of the insulation (unitless)  
 $R_1$ : radius of the wire (m)  
 $e$ : insulation thickness (m)  
 $R_D$ : disc radius (m)

Then:

$$e = \frac{\pi^2 \epsilon_0 \epsilon_r R_1 (R_D - R_1)}{2C + \epsilon_0 \epsilon_r R_1 \pi^2} \quad (5)$$

The length of the wire that is in contact with the disc is not known with precision. However, by using the above formula, it is assumed that it is exactly the half of the circumference of the disc.

**Table 3** : Results

	Voltage (V)	Capacitance ( $\times 10^{-12}$ F)	Width ( $\times 10^{-6}$ m)
Side 1	3,171	49,20	25,68
Side 2	3,292	47,38	26,66

This example makes it possible to definitively validate the feasibility of the concept of dielectric measurement. Indeed, the deviation of the value of the capacitance results in a voltage difference.

A complete study of wire eccentricity requires training at least four capacitors to compare the thicknesses on four sides of the wire. Thus, the measuring device will be formed of four discs having a slot with a perimeter equal to a quarter of that of the wire.

## 5. Conclusions

The preliminary study carried out in this paper makes possible to check the principle of the eccentricity measurement of an enameled wire by an electrical method. As it is possible to translate the thickness of the dielectric into DC voltage, it is possible to make the comparison between several thicknesses.

The device designed will be added to the wire production line available at the laboratory, in order to determine the wire eccentricity. This will allow a precise adjustment at the beginning of the process, and also a continuous monitoring during the manufacture of the wire. A complete study of the eccentricity of the wire requires the formation of at least four capacitors to compare the thickness on the four sides of the wire.

**Author Contributions:** Conceptualization, G.V.; experiments, A.K.; validation, formal analysis, S.A. A.K. and G.V.; writing—original draft preparation, S.A. and A.K.; reviewing, G.V. All authors have read and agreed to the published version of the manuscript.

**Funding:** This research received no external funding.

**Institutional Review Board Statement:** Not applicable.

**Informed Consent Statement:** Not applicable.

**Conflicts of Interest:** The authors declare no conflict of interest.

## References

- Shugg, W. T. Handbook of Electrical and Electronic Insulating Materials, Wiley-IEEE Press, 1995.

- 358 2. Winkeler, M. Magnet wire enamels-which one?, IEEE Electrical Insulation Magazine, vol. 7, no. 4, pp. 61-64, July-Aug. 1991.
- 359 3. IEC 60317-0-1, Specifications for particular types of winding wires - part 0-1: General requirements - enamelled round copper  
360 wire, 2013.
- 361 4. IEC 60851-5. Winding wires – Test methods – Part 5: Electrical properties, 2019.
- 362 5. IEC 60505. *Evaluation and qualification of electrical insulation systems*, 2011.
- 363 6. IEC 60172. Test procedures for the determination of the temperature index of enameled and tape wrapped winding wires, 2015.
- 364 7. Boughanmi, W. Eco-conception des motorisations électriques: Application à la machine asynchrone, PhD thesis in Electrical  
365 Power Engineering of Université d'Artois, France, 2012.
- 366 8. W. Boughanmi, J. P. Manata, D. Roger, T. Jacq and F. Streiff, " Life cycle assessment of three-phase electrical machines in con-  
367 tinuous operation", EPA – IET, vol. 6(5), pp. 277-285, 2012.
- 368 9. Ait-Amar, S. Ben Fatallah, M. Habas, A. Habas, J.P. Notingher, P. Frezel, P, Properties of a new ecoefficient coating for magnet  
369 wire,"2013 IEEE International Conference on Solid Dielectrics (ICSD), 2013, pp. 553-556.
- 370 10. Ait-Amar, S. et al., Dielectric parameters study of insulation wire free of volatile organic compound," 2012 Annual Report Con-  
371 ference on Electrical Insulation and Dielectric Phenomena, 2012, pp. 866-869.
- 372 11. Stone, G. C.; Culbert, I.; Boulter, E. A.; Dhirani, H. Electrical insulation for rotating machines-design, evaluation, aging, testing,  
373 and repair, Wiley-IEEE Press, 2004.
- 374 12. IEC 60270, High-voltage test techniques, partial discharge measurements, 2001.
- 375 13. Gianoglio, C.; Ragusa, E.; Gastaldo, P.; Gallesi, F.; Guastavino, F. Online Predictive Maintenance Monitoring Adopting Convo-  
376 lutional Neural Networks. *Energies* 2021, 14, 4711.
- 377 14. Florkowski, M.; Florkowska, B.; Zydron, P. Partial Discharges in Insulating Systems of Low Voltage Electric Motors Fed by  
378 Power Electronics – Twisted-Pair Samples Evaluation. *Energies* 2019, 12, 768
- 379 15. Höpner, V.N.; Wilhelm, V.E. Insulation Life Span of Low-Voltage Electric Motors—A Survey. *Energies* 2021, 14, 1738
- 380 16. [www.zumbach.com](http://www.zumbach.com).
- 381 17. [www.sikora.net](http://www.sikora.net)
- 382 18. Du, W. Y. Resistive, Capacitive, Inductive, and Magnetic Sensor Technologies, CRC Press, 2015.
- 383 19. Kitchin, C.; Counts, L. *A designer's guide to instrumentation amplifiers*, Analog Devices, Inc, 2006.