



HAL
open science

Damper winding for noise and vibration reduction of PWM-fed induction machines

Gregory Bauw, Francois Balavoine, Bertrand Cassoret, Olivier Ninet, Raphael
Romary

► **To cite this version:**

Gregory Bauw, Francois Balavoine, Bertrand Cassoret, Olivier Ninet, Raphael Romary. Damper winding for noise and vibration reduction of PWM-fed induction machines. 2017 IEEE International Electric Machines and Drives Conference (IEMDC), May 2017, Miami, United States. pp.1-6, 10.1109/IEMDC.2017.8002061 . hal-04132657

HAL Id: hal-04132657

<https://univ-artois.hal.science/hal-04132657v1>

Submitted on 29 Nov 2023

HAL is a multi-disciplinary open access archive for the deposit and dissemination of scientific research documents, whether they are published or not. The documents may come from teaching and research institutions in France or abroad, or from public or private research centers.

L'archive ouverte pluridisciplinaire **HAL**, est destinée au dépôt et à la diffusion de documents scientifiques de niveau recherche, publiés ou non, émanant des établissements d'enseignement et de recherche français ou étrangers, des laboratoires publics ou privés.

Damper winding for noise and vibration reduction of PWM-fed induction machines

Grégory BAUW, François BALAVOINE, Bertrand CASSORET, Olivier NINET, Raphaël ROMARY
Univ. Artois, EA 4025, Laboratoire Systèmes Electrotechniques et Environnement (LSEE), F-62400 Béthune, France

Abstract—The paper presents a system that allows the passive reduction of noise and vibration of a three-phase induction machine with a stator damper winding connected to capacitors. This is a simple and effective system for reducing the flux density harmonics of a machine. The theoretical study is based on the equivalent circuit of a machine equipped with the damper winding and the modeling is based on the analogy with a single-phase two-winding electrical machine. Analysis of the equivalent circuit allows to identify opportunities to reduce the flux density harmonics. Finally, an experimental validation is done.

Keywords—Induction machine, noise, vibrations, harmonics, auxiliary winding, damper, PWM.

I. INTRODUCTION

For user comfort reasons, the audible noise of electrical machines has become a fundamental aspect to be treated from conception [1]. It is also a parameter to consider in many areas, such as the military one for example where the acoustic discretion is required [2], [3]. Moreover, vibration problems can cause disruption of the surrounding environment or premature mechanical wear. The overall noise level of an electrical machine results from three main sources: mechanical, aerodynamic and magnetic [4]. That paper will essentially focus on the magnetic one which can be predominant especially when the machine is powered by a Pulse Width Modulation (PWM) inverter [5].

Actually, the magnetic noise is generated by the magnetic forces in the machine. Maxwell forces that attract the stator and the rotor cause deformations of the stator, and therefore noise and vibrations. They are related to the presence of flux density harmonics in the air gap. These harmonics may be generated by the slotting effect, saturation, eccentricity or by harmonics due to PWM power supply. These can lead to a significant specific noise.

Various methods are available to reduce the noise of an electric machine:

- When the machine is fed by the network, the design must respect the rules of construction of the machines [6] by choosing an adequate number of stator and rotor slots. On the other hand, previous work suggested, for example, to reduce the noise by injecting a harmonic current system in the windings, thus creating opposing forces with those

naturally generated by the machine [7]. These harmonic currents can also be injected into an auxiliary winding [8]. Another method suggests to use piezoelectric actuators to reduce the vibration produced by the machine and therefore reduce the overall noise level [9].

- When the machine is PWM-fed, the most common method is to increase the switching frequency beyond the audible range, but it affects the loss and heating of electronic components. Moreover, this is not possible for high power machines.

The method proposed in this paper is based on the generation of currents induced in auxiliary windings connected to passive elements. We will start with the description of a prototype including this technology and a theoretical analysis highlighting the resonances. Then we will conclude with experimental results demonstrating the validity and the effectiveness of the method.

II. TECHNICAL DESCRIPTION OF THE SYSTEM

A. General Description

The proposed system allows the passive reduction of air-gap flux density harmonics in an induction machine. The idea is to add into the slots a second three-phase winding superimposed to the stator winding, but electrically independent as shown in Fig. 1. This one will be named the damper or the auxiliary winding.

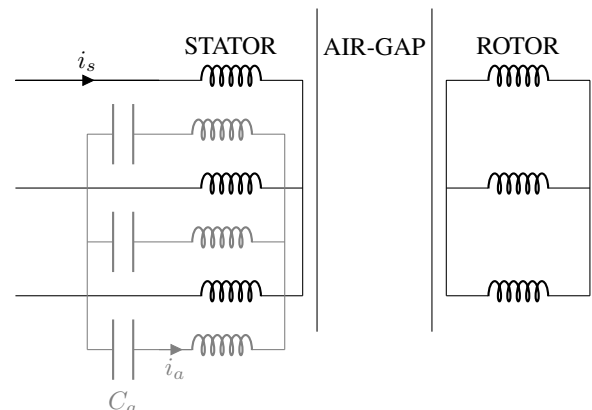

Fig. 1. Diagram of a machine with damper windings

Acknowledgment: SATT Nord de France (Société d'Accélération du Transfert de Technologie), CE2I (Convertisseur d'Énergie Intégré Intelligent).

Star or delta connected, the auxiliary windings are simply connected to 3 capacitors of suitable values. The rotor remains shorted-circuited as in all induction machines.

The main principle is that the flux density harmonics create induced currents in the auxiliary windings, which in turn create flux density waves opposed to the cause that produce them.

At low supply frequency (typically 50 or 60 Hz, or less in variable speed), capacitors have a high impedance so that the induced currents in the auxiliary windings keep low values. Depending on the value of the capacitors and the number of turns of the auxiliary windings, these currents at supply frequency can, however, create a part of the reactive power required for the magnetization of the magnetic circuit and reduce the magnetizing current absorbed by the stator and the associated Joules losses (power factor improvement) [10]–[13].

At high PWM frequency, unwanted flux density waves create high frequency induced currents in the auxiliary windings, for which the impedance is low. Therefore, the flux density in the air-gap becomes more sinusoidal.

B. Studied Prototype

The results presented in this paper are relative to a 4kW prototype of induction machine with damper windings. Its characteristics are: 230/400 V - 15.3/8.8 A - 1435 rpm - p=2 pole pairs.

The damper or auxiliary winding is clearly visible in Fig. 2, it is wound at the top of the slots, over the stator winding and near the air-gap. Arbitrarily, the number of turns and the pattern of the two three-phase windings are equivalent, each of them has 26 turns per slot; only the section is different. The section of the stator winding is about 1 mm² while the section of the auxiliary one is 0.159 mm². This section was chosen in order to obtain a maximum fill factor. In this case, the damper winding takes up less than 15% of the total available space into the slots.

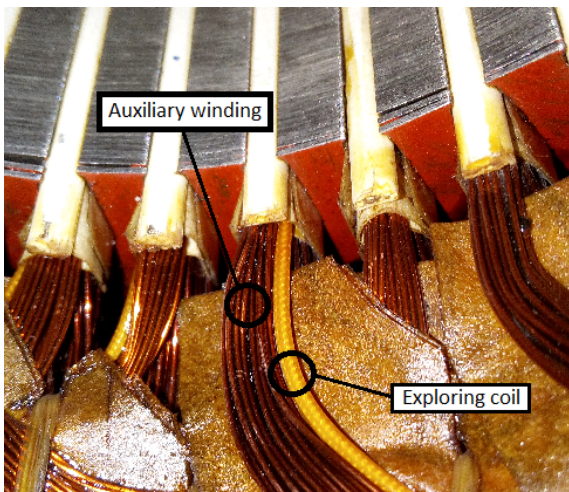

Fig. 2. Auxiliary winding of the studied prototype

One can also distinguish in Fig. 2 an exploring coil (in yellow) following the path of one turn of the stator winding. This coil allows us to visualize the image of the electromotive force of the machine, proportional to the derivative of the flux density in the air gap.

III. SINGLE-PHASE TWO-WINDING ELECTRICAL MACHINE MODELING

The single-phase equivalent circuit is given in Fig. 3. This is the classical single-phase equivalent circuit of the induction machine in which is added an auxiliary branch including the resistance and the leakage inductance of the winding as well as the capacitor connected in series therewith. All the physical variables and parameters are brought back to the stator.

The analogy of our system with the single-phase two-winding transformer allows one to create a simple analytical model and thus to understand the behavior of the various involved variables. For this, we consider the equivalent circuit presented in Fig.4, where the influence of the rotor and the iron losses are neglected. Indeed, the damping effect of the rotor is less than that the auxiliary one which has a lower leakage inductance l'_a .

The supply voltage V_s of the induction machine corresponds to one harmonic voltage of the PWM inverter at ω angular

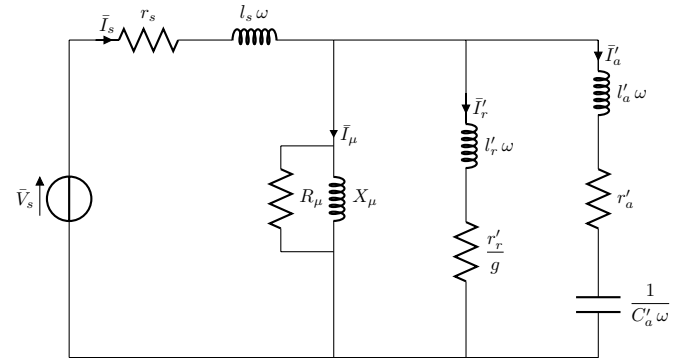

Fig. 3. Single-phase equivalent circuit

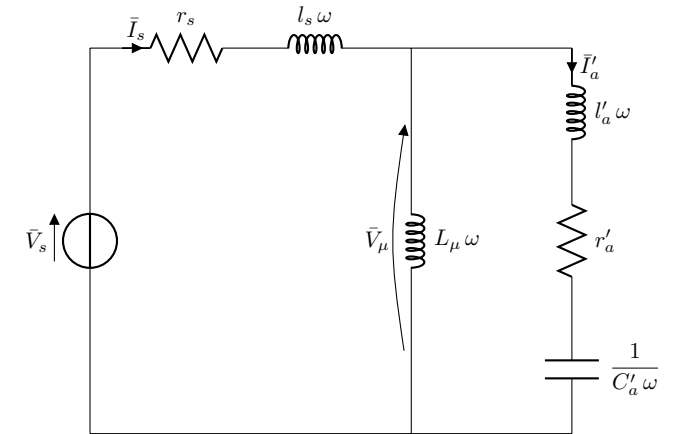

Fig. 4. Single-phase two-winding equivalent circuit

frequency. The current \bar{I}_s flows through the stator winding and induces a current \bar{I}'_a in the auxiliary winding.

Let define:

- ω : angular frequency such as $\omega = 2\pi f$ with f the frequency;
- r_s, r'_a : stator and auxiliary winding resistances;
- l_s, l'_a : stator and auxiliary leakage inductances;
- n_s, n_a : numbers of turns of the stator and auxiliary windings;
- $C'_a = C_a \left(\frac{n_s}{n_a}\right)^2$: capacitor in series with the auxiliary winding brought back to the stator;
- L_μ : magnetizing inductance;
- L_s, L'_a : magnetizing inductances of the stator and auxiliary windings such as
 - $L_s = L_\mu$
 - $L'_a = L_\mu \left(\frac{n_s}{n_a}\right)^2$
- M : mutual inductance between the two windings such as $M = \sqrt{L_s L'_a}$;
- Φ : common magnetic flux to the both windings and channeled by the magnetic circuit such as $\bar{V}_\mu = j\omega n_s \bar{\Phi}$.

The equivalent complex impedance of the electrical machine taken from the stator is expressed by:

$$\begin{aligned} \bar{Z}_{eq} &= \frac{1}{r'_a + j((L_s + l'_a)\omega - \frac{1}{C'_a\omega})} \\ &\times \left[r_s r'_a + L_s \left(\frac{1}{C'_a} - l'_a \omega^2 \right) - l_s \left((L_s + l'_a) \omega^2 - \frac{1}{C'_a} \right) \right. \\ &\quad \left. + j \left(r_s \left((L_s + l'_a) \omega - \frac{1}{C'_a \omega} \right) + r'_a (L_s + l'_a) \omega \right) \right] \quad (1) \end{aligned}$$

The study of this impedance shows the existence of two resonances:

- a series resonance f_{rs} which can be expressed by:

$$\begin{aligned} f_{rs} &= \frac{1}{2\pi} \sqrt{\frac{L_s + l_s}{C'_a(L_s l_s + l_s l'_a + L_s l'_a)}} \\ &\approx \frac{1}{2\pi} \sqrt{\frac{1}{C'_a(l_s + l'_a)}} \quad (2) \end{aligned}$$

Neglecting the product of leakage inductances $l_s l'_a$ and assuming that $L_s + l_s$ is about the same as L_s we highlight the series nature of this resonance where C'_a resonates with l_s in series with l'_a .

- a parallel resonance f_{rp} done by (3), where C'_a mainly resonates with L_s :

$$f_{rp} = \frac{1}{2\pi} \sqrt{\frac{1}{C'_a(L_s + l'_a)}} \quad (3)$$

TABLE I
CHARACTERISTICS OF THE 4 kW STUDIED MACHINE

$V_s = 230 \text{ V}$	$L_s = L'_a = 0.126 \text{ H}$	$r_s = 1.6 \Omega$
$n_s = n_a = 26 = \text{turns}$	$l_s = l'_a = 0.0085 \text{ H}$	$r_a = 10 \Omega$

The following numerical applications relate to the 4 kW machine previously described, whose main characteristics are given in Table I. One can notice that r'_a is higher than r_s because the wire section of the auxiliary winding is smaller than that of the stator winding.

The frequency response of the currents shown in Fig. 5 illustrates these two resonances. The parallel resonance f_{rp} at 217 Hz leads to a minimum current in the stator winding while the series resonance f_{rs} at 620 Hz leads to the maximum.

The resulting magnetic flux Φ in the iron core can also be expressed by:

$$\Phi = \frac{L_s I_s}{n_s} - \frac{M I'_a}{n_s} = \frac{M I_s}{n_a} - \frac{L'_a I'_a}{n_a} = \frac{V_\mu}{n_s \omega} \quad (4)$$

Fig. 6. shows this flux (solid line) as a function of the frequency for $C'_a = 4 \mu\text{F}$. The magnetic flux that would naturally exist without the presence of the auxiliary winding (dashed line), is also presented.

We can notice that for low frequencies, and particularly at 50 Hz, these two magnetic flux are similar and therefore the system does not disturb the normal running of the machine. However, there is a frequency range around 600 Hz for which the system amplifies the flux. It is therefore necessary to choose the value of C'_a with attention. For higher frequencies, here from 710 Hz, the flux Φ is less than the initial one, highlighting the fact that the auxiliary winding is opposed to the harmonic effects. Consequently, the system will be beneficial when the switching frequency of the PWM inverter

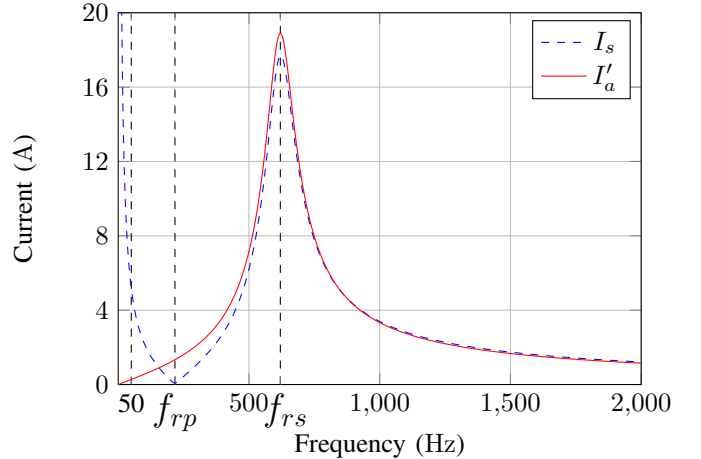

Fig. 5. I_s (dashed line) and I'_a (solid line) as a function of the frequency for $C'_a = 4 \mu\text{F}$

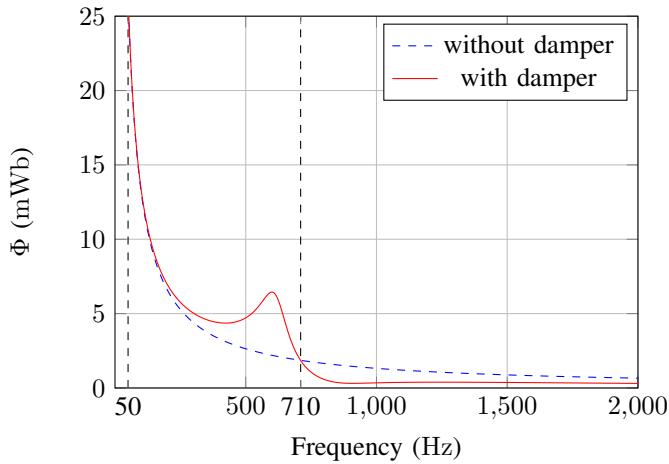

Fig. 6. Magnetic flux with (solid line) and without (dashed line) damper winding as a function of the frequency for $C'_a = 4 \mu\text{F}$

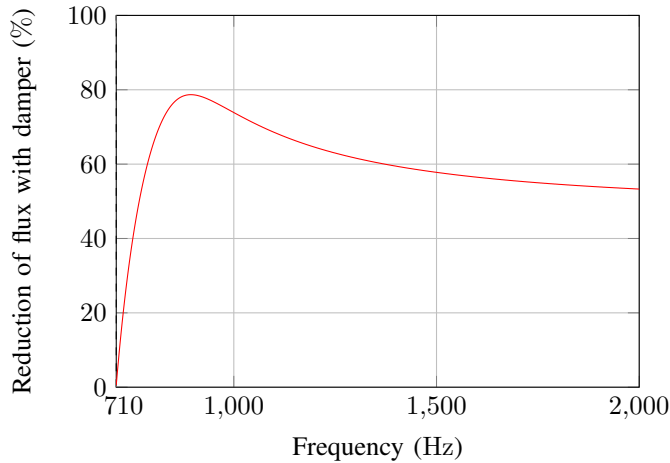

Fig. 7. Reduction of magnetic flux with damper winding as a function of the frequency for $C'_a = 4 \mu\text{F}$

is greater than 710 Hz. Fig. 7 shows the percentage reduction of flux with damper beyond this frequency with respect to Φ without damper. It can reach up to 80% in the best case but the attenuation decreases as the frequency of the PWM increases. The reduction is identical for the flux density that produces the noise as it is proportional to the flux.

IV. COMPARISON OF THE DAMPER WINDING WITH AN ANTI-HARMONIC FILTER

Usually, unwanted frequencies due to PWM power supply at the origin of magnetic noise are mitigated using a passive filter, also called anti-harmonic filter. Depending on the used technology, this type of filter can also limit the premature aging of the conductors due to voltage front edge. The proposed damper winding operates in a similar manner. It requires to have enough space in the slots but the advantages of using a three-phase damper winding wound into the slots of the machine are real.

First of all, from a user point of view, the proposed solution offers an easy commissioning and maintenance. Its compact size is a non negligible advantage in comparison with a filter that often requires its own electrical cabinet. One can imagine that the capacitors could be included in the terminal box of the machine and thus become transparent to the user.

On the other hand, if the addition of copper can appear as a constraint, the economy is done on the volume of iron. Indeed, the auxiliary windings take advantage of the existing magnetic circuit. In the same time, the addition of an inductance which is likely to be noisy is avoided.

Finally, since the system is inside the machine, it also makes it possible to act on the frequencies due to internal phenomena such as slot harmonics in the case of a sinusoidal power supply. This is of course not possible with a filter placed upstream.

V. EXPERIMENTAL RESULTS

A. Test Bench Presentation

The machine used for the following experiments is presented in Fig. 8, its characteristics are detailed in section II-B. The latter is PWM-fed by an inverter whose possible switching frequencies are 3, 4, 6 and 8 kHz. One can notice the capacitor box whose size is similar to that of the terminal box of the machine. Three switches allow us to easily open or close the auxiliary circuit. The capacitors used have a value of $4 \mu\text{F}$.

B. Sinusoidalization of the Flux Density in the Air-gap

The exploring coil wound into the slots of the studied machine and described previously in the paper gives us the opportunity to measure the electromotive force.

The machine is PWM-fed with a switching frequency of 8 kHz. In this way, it is shown in Fig. 9 and Fig. 10 that this physical quantity becomes more sinusoidal thanks to the damper windings and its three $4 \mu\text{F}$ capacitors. Since the electromotive force is proportional to the derivative of the flux density in the air-gap, the flux density harmonics are reduced, and therefore magnetic noise and vibrations.

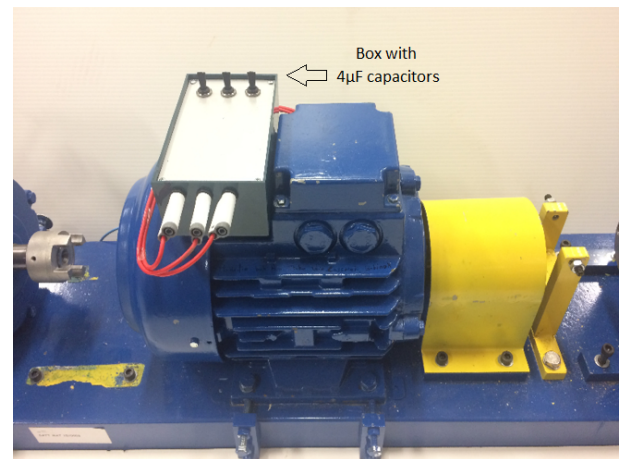

Fig. 8. Presentation of the test bench

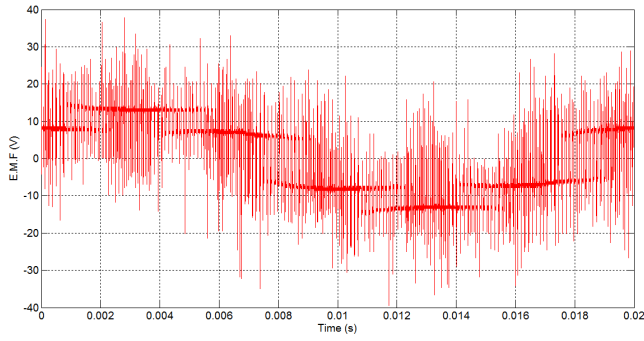

Fig. 9. Electromotive force without damper windings for $f_{PWM} = 8 \text{ kHz}$

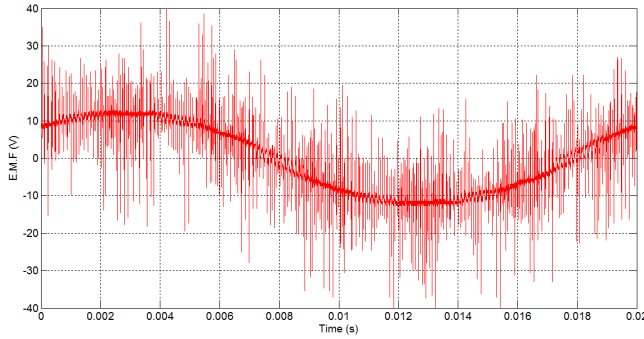

Fig. 10. Electromotive force with damper windings for $f_{PWM} = 8 \text{ kHz}$

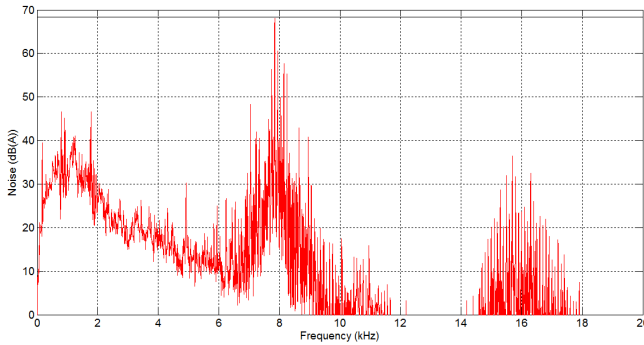

Fig. 11. Noise spectrum without damper windings for $f_{PWM} = 8 \text{ kHz}$

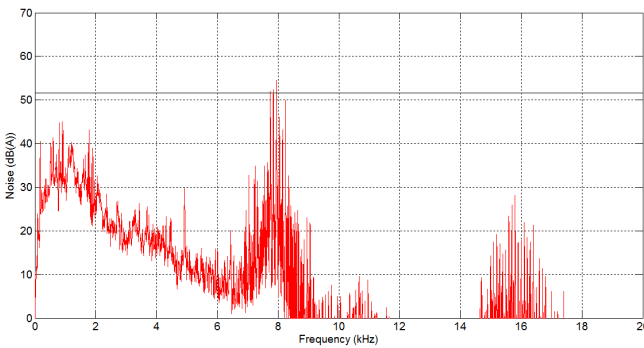

Fig. 12. Noise spectrum with damper windings for $f_{PWM} = 8 \text{ kHz}$

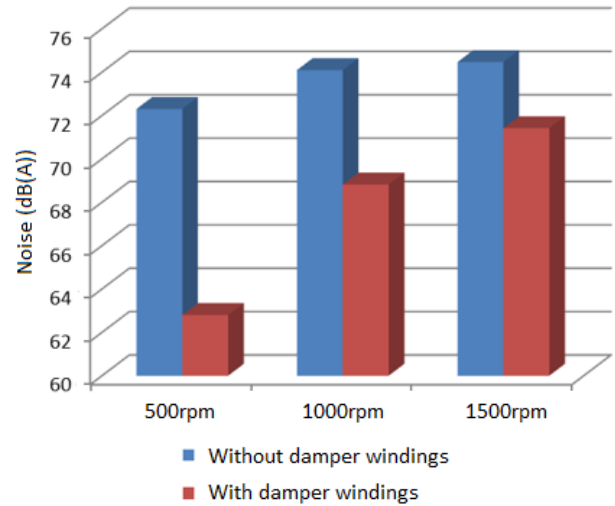

Fig. 13. Sound power level without and with damper circuit for different speeds

C. Noise Spectra

Noise measurements have been performed in a semi-anechoic chamber on the 4 kW three-phase PWM-fed induction machine with a microphone at a distance of 1 m. The switching frequency is 8 kHz and the presented spectra use a weighting coefficient to take the sensitivity of the human ear into account (A weighting).

Fig. 11 and Fig. 12 clearly show that the lines around the switching frequency, which are predominant in the spectrum, are greatly mitigated thanks to the damper system. The line at 7850 Hz decreased from 68 dB(A) to 52 dB(A) and the overall sound pressure level is reduced by more than 8.5 dB(A) in this case.

D. Influence of the Speed on Noise Reduction

In order to highlight the influence of the speed on the effectiveness of the system, the overall sound power level has been measured for several speed values. The machine operates at no-load but the PWM inverter, whose switching frequency is now set to 4 kHz, allows us to vary the speed. One can notice in Fig. 13 that the noise reduction is more important at 500 rpm. Actually, since the magnetic noise is predominant in the spectral content of the machine at low speed, the effectiveness of the system is optimal for this operating point.

Noise reduction can even be observed when the machine is stopped but fed by the PWM inverter.

E. Vibration spectra

Vibration measurements have been performed with an accelerometer fixed on the housing of the machine, under the same conditions as for noise measurements. Fig. 14 and Fig. 15 show the considerable decrease of the vibrations acceleration. In this case, the overall vibration level decreased from 52.6 m/s^2 to 13.7 m/s^2 .

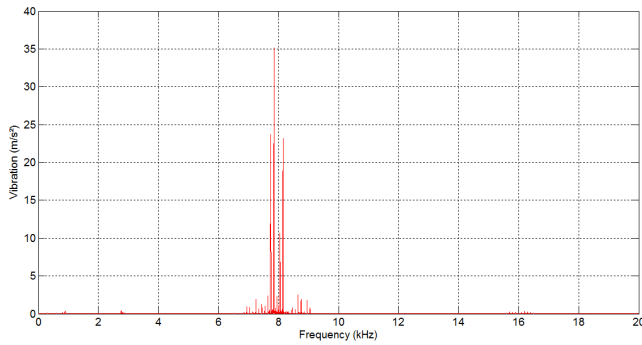

Fig. 14. Vibration spectrum without damper windings for $f_{PWM} = 8$ kHz

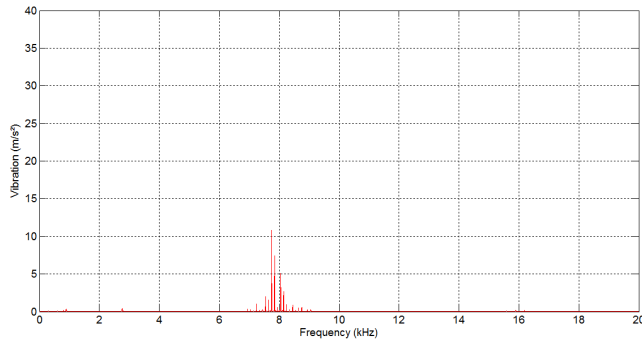

Fig. 15. Vibration spectrum with damper windings for $f_{PWM} = 8$ kHz

VI. CONCLUSION

The proposed system can significantly reduce the magnetic noise passively, without using complex electronics and without any regulation. The obtained reduction is stable over time, even when the machine speed varies. A wide range of capacitor values is suitable. The system has the disadvantage of requiring space in the slots to add the auxiliary windings. Nevertheless, the latter are carrying low currents and require less space than the original windings.

The model presented in this paper provides an understanding of the parameters that affect the behavior of the system. It also allows to optimally size the windings and the capacitors for a given machine.

ACKNOWLEDGMENT

The authors would like to thank SATT Nord de France (Société d'Accélération du Transfert de Technologie) that has patented this invention [14] and that allowed us to fund prototypes of modified machines and the necessary equipment for our experiments.

This work has been achieved within the framework of CE2I project (Convertisseur d'Energie Intégré Intelligent). CE2I is co-financed by European Union with the financial support of European Regional Development Fund (ERDF), French State and the French Region of Hauts-de-France.

REFERENCES

- [1] J. Le Besnerais, V. Lanfranchi, M. Hecquet, R. Romary, P. Brochet *et al.*, "Optimal slot opening width for magnetic noise reduction in induction motors," *IEEE Transactions on Energy Conversion*, vol. 24, no. 4, p. 869, 2009.
- [2] G. Le Coat, "Discretion électromagnétique des machines électriques tournantes," Ph.D. dissertation, Institut National Polytechnique de Grenoble-INPG, 1997.
- [3] K. Borisov, T. E. Calvert, J. A. Kleppe, E. Martin, and A. M. Trzynadlowski, "Experimental investigation of a naval propulsion drive model with the pwm-based attenuation of the acoustic and electromagnetic noise," *IEEE Transactions on Industrial Electronics*, vol. 53, no. 2, pp. 450–457, 2006.
- [4] P. L. Timar, A. Fazekas, J. Kiss, A. Miklos, and S. J. Yang, "Noise and vibration of electrical machines," 1989.
- [5] J. Le Besnerais, "Reduction of magnetic noise in PWM-supplied induction machines - low-noise design rules and multi-objective optimization," Theses, Ecole Centrale de Lille, Nov. 2008. [Online]. Available: <https://tel.archives-ouvertes.fr/tel-00348730>
- [6] H. Jordan, *Geräuscharme elektromotoren*. W. Girardet, 1950.
- [7] B. Cassoret, R. Corton, D. Roger, and J.-F. Brudny, "Magnetic noise reduction of induction machines," *IEEE Transactions on power electronics*, vol. 18, no. 2, pp. 570–579, 2003.
- [8] J.-P. Lecointe, R. Romary, J. Brudny, and M. McClelland, "Analysis and active reduction of vibration and acoustic noise in the switched reluctance motor," *IEE Proceedings-Electric Power Applications*, vol. 151, no. 6, pp. 725–733, 2004.
- [9] X. Ojeda, X. Mininger, H. B. Ahmed, M. Gabsi, and M. Lécrivain, "Piezoelectric actuator design and placement for switched reluctance motors active damping," *IEEE Transactions on Energy Conversion*, vol. 24, no. 2, pp. 305–313, 2009.
- [10] D. Nicolae, *Electric motor performance improvement using auxiliary windings and capacitance injection*. INTECH Open Access Publisher, 2011.
- [11] E. Muljadi, T. A. Lipo, and D. W. Novotny, "Power factor enhancement of induction machines by means of solid-state excitation," *IEEE transactions on power electronics*, vol. 4, no. 4, pp. 409–418, 1989.
- [12] A. R. Muñoz and T. A. Lipo, "Dual stator winding induction machine drive," *IEEE Transactions on Industry Applications*, vol. 36, no. 5, pp. 1369–1379, 2000.
- [13] E. S. Obe, "Steady-state performance of a line-start synchronous reluctance motor with capacitive assistance," *Electric Power Systems Research*, vol. 80, no. 10, pp. 1240–1246, 2010.
- [14] B. Cassoret and R. ROMARY, "Moteur électrique a enroulement auxiliaire isole," Dec. 29 2016, wO Patent App. PCT/EP2016/064,319. [Online]. Available: <https://www.google.com/patents/WO2016207166A1?cl=fr>