



HAL
open science

Impact of Mechanical Deformations of Transformer Corners on Core Losses

Remi Penin, Guillaume Parent, Jean-Philippe Lecointe, Jean-Francois Brudny,
Thierry Belgrand

► **To cite this version:**

Remi Penin, Guillaume Parent, Jean-Philippe Lecointe, Jean-Francois Brudny, Thierry Belgrand. Impact of Mechanical Deformations of Transformer Corners on Core Losses. IEEE Transactions on Magnetics, 2015, 51 (4), pp.8400605. <10.1109/TMAG.2014.2363057>. <hal-03350801>

HAL Id: hal-03350801

<https://univ-artois.hal.science/hal-03350801v1>

Submitted on 17 May 2022

HAL is a multi-disciplinary open access archive for the deposit and dissemination of scientific research documents, whether they are published or not. The documents may come from teaching and research institutions in France or abroad, or from public or private research centers.

L'archive ouverte pluridisciplinaire **HAL**, est destinée au dépôt et à la diffusion de documents scientifiques de niveau recherche, publiés ou non, émanant des établissements d'enseignement et de recherche français ou étrangers, des laboratoires publics ou privés.



HAL Authorization

Impact of Mechanical Deformations of Transformer Corners on Core Losses

Rémi Penin^{1,2,3}, Guillaume Parent^{1,2}, Jean-Philippe Lecoïnte^{1,2},
Jean-François Brudny^{1,2}, *Senior Member, IEEE* and Thierry Belgrand³

¹ Univ. Lille Nord de France, F-59000 Lille, France

² UArtois, LSEE, F-62400 Béthune, France

³ ThyssenKrupp Electrical Steel, F-62330 Isbergues, France

The clamping of the power transformer magnetic circuit allows maintaining the sheet stack and provides an additional mechanical rigidity. It has consequences on the acoustic noise of transformers as the magnetic cores of power transformers vibrate because of the magnetostriction and, if the corners are considered, Maxwell's forces. The indirect impact of a lack of clamping on the core losses is studied, especially on the interlaminar air gaps in the corners. In this paper, it is shown numerically with Finite Element modelling and experimentally with a specific test bench that induced vibrations can change the flux distribution and thus the losses.

Index Terms—Magnetic losses, transformer cores, vibrations.

I. INTRODUCTION

THE magnetic core of power transformers is most of the time made of Grain Oriented (GO) steel laminations, which have the best performances in the Rolling Direction (RD). The magnetic core clamping allows maintaining the laminations assembly and provides an additional mechanical rigidity. Several studies have shown that this clamping modifies the GO sheet properties such as the permeability or the magnetostrictive behavior [1,2]. In a transformer core, two vibration sources make the sheets vibrating, especially in the corners areas. The first one is the magnetostriction, which occurs when the magnetic material domains rotate in order to be aligned along the magnetic field direction [3]. The second one is the Maxwell's forces, which take place between the laminations when the magnetic flux crosses the air gaps. The latter phenomenon is particularly standing inside the corners because the step lap joints are composed of thin anisotropic laminations, of crossing RDs, and of air gaps. Thus Maxwell's forces occur in two directions: in plane and out of plane of the sheets [4]. In this paper, the authors analyze the impact of a lack of clamping and of a non-uniform clamping [5] on the core losses. They present in the first part the experimental measurement results obtained with a single phase transformer core structure, for which various pressures have been applied on corners. The second part presents a 2D Finite Element (FE) model of the transformer core structure. The latter brings information about the change in the magnetic flux distribution inside the transformer core with respect to geometry variations due to a non-uniform clamping. The last part is a discussion, about the link between the magnetic core deformations and the core losses.

II. EXPERIMENTAL MEASUREMENTS

A. Experimental Device

A single phase transformer core has been built in order to quantify the impact of the clamping pressure on the losses (Fig. 1). It is made of GO "Powercore H" sheets of 0.30 mm thickness. The external dimensions are 0.5 m by 0.4 m. The legs are made with 60 sheets with a width of 100 mm and the corners are Butt-Lap configuration. The primary and secondary windings are made of 104 turns uniformly wound around the 4 legs. The secondary voltage is monitored in order to adjust the global flux density value. The primary winding is supplied with a 50 Hz sinusoidal voltage. Four different operating points have been considered 1.5 T, 1.6 T, 1.7 T and 1.8 T in order to estimate the influence of saturation effects.

Each corner is put under pressure normal to the steel surface using non magnetic weights. Those can be accurately adjusted. Wooden plates are placed between corners and weights in order to apply an uniform pressure. Various pressure values have been considered: 0 Pa, 200 Pa, 400 Pa, 600 Pa, 800 Pa, 1000 Pa.

For each pressure value previously mentioned, two kinds of quantity have been measured :

- the core losses, thanks to a precision wattmeter (Yokogawa WT230) measuring simultaneously the primary current and the secondary voltage
- the deformations, measured thanks to 2 accelerometers Bruël&Kjaer, Type 4397) placed respectively on the center-part and near the interior side of the corner joint (Fig. 2). The measurements are analyzed with a Pulse spectrum analyzer station.

The pressure values are several times lower than the ones usually applied on clamped parts in industrial transformers. However, the goal of applying these pressures on the whole corners consists in highlighting trends of both losses and vibrations with the pressures.

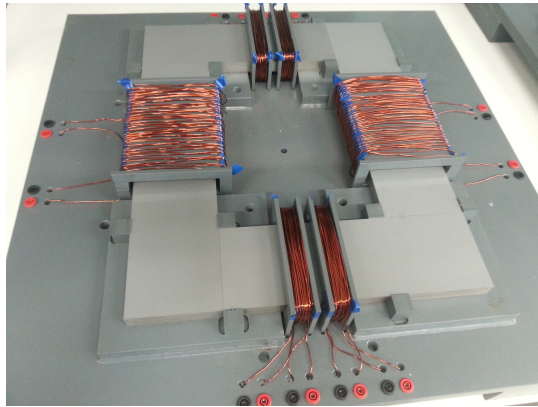
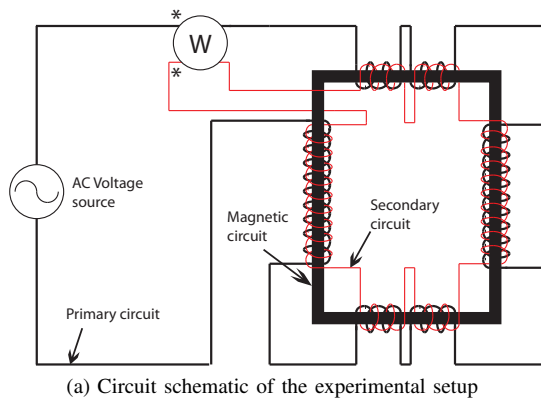

Fig. 1. Experimental setup

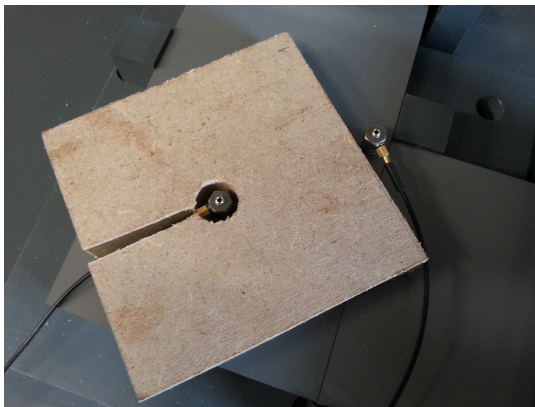

Fig. 2. Measuring points on the transformer corner

B. Measurement Results

Core loss variations with pressure at the flux density values mentioned in II-A are presented in Fig. 3. The results highlight a decrease of the losses, up to 8.27% between 0 Pa and 1000 Pa at $B=1.6$ T. The decrease can be explained by the fact that the pressure:

- limits the air gap fluctuations and modifies the magnetic flux distribution inside the core
- homogenizes the interlaminar air gap thickness and, as a consequence, increases the efficiency of the core.

The first point is verified with the deformations measurements shown in Fig. 4. At 1.5 T, the corner deformations

decrease drastically of 52% in the middle of the corner (Fig. 4a) and of 82.7% in the interior of the corner (Fig. 4b). It means that the limitation of the corner deformation reduces the air gap variations. In order to understand the influence of the deformations on the flux distribution, a FE model has been developed.

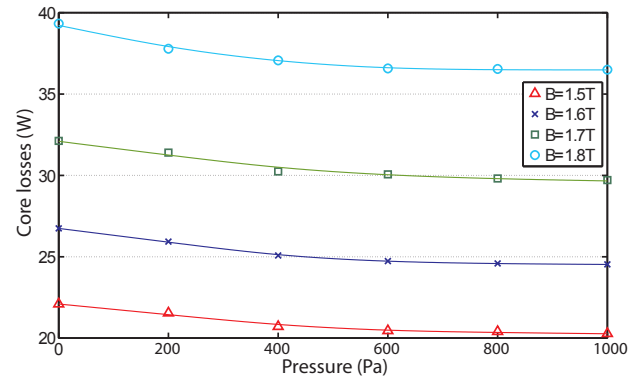

Fig. 3. Core losses variations with respect to the applied pressure and the flux density (measurements and trend curves)

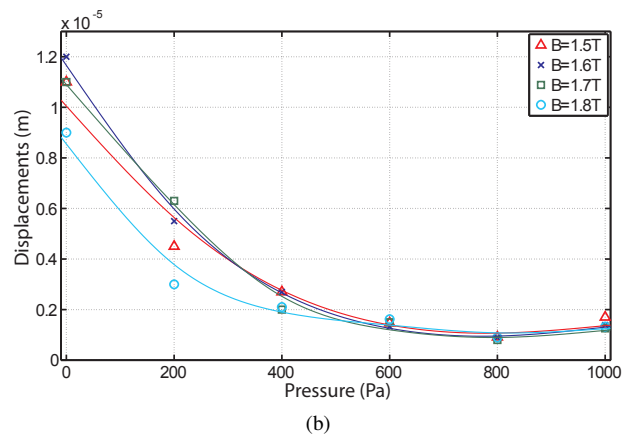
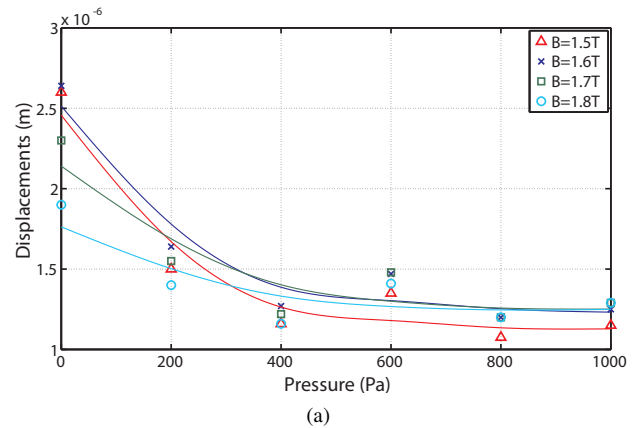

Fig. 4. Displacements with the pressure and the flux density in the middle (a) and the interior (b) of the corner (measurements and trend curves)

III. FINITE ELEMENT MODEL

A. Model Definition

A FE model taking into account the real geometry of the transformer, *ie* taking into account at once the sheets and the interlaminar air gaps, would lead to an extremely high computation time issue. Hence, in order to get a FE model representative enough of our problem with a descent computation time, a developed magnetic core diagram which is often used for winding rotating electrical machines representation has been modeled (Fig. 5). It models the transformer presented in section II-A in a schematic outline [6,7], which takes into account the 4 legs and the 4 corners. Each leg is made of a stack of ten 0.30 mm nominal thickness sheets and the interlaminar air gap thicknesses are adjustable. The non-linearity (saturation and anisotropy) of the sheets is taken into account [8]. The in plane characteristics of the sheets have been determined with the Epstein frame method [9]. The relative permeability in the normal direction, equal to 28.6, has been determined experimentally with a specific test bench described in [10]. Periodic boundary conditions are applied on the left and right sides of the model. An operating point at $B=1.6$ T is considered and the following cases are studied:

- case 1: all the interlaminar air gaps have the same thickness,
- case 2: one air gap thickness is different from the others,
- case 3: all the air gaps thicknesses are different.

The flux distribution is studied along two lines (Fig. 6). The first one cuts the stack near a corner whereas the other one passes through the middle of plane air gaps (Fig. 5). As an example, Fig. 6 shows the flux distribution obtained with the model in a case where all the interlaminar air gaps have the same thickness ($5\mu\text{m}$): the magnetic flux density establishes itself according to the less reluctant path. This leads to local saturations in the corners every two sheets and to very low magnetic flux density every two other sheets [11].

B. Case 1

In this case, all the interlaminar air gaps have same thickness. This latter can take different values: $5\mu\text{m}$, which is considered as the reference value (REF), $10\mu\text{m}$ and $15\mu\text{m}$. Fig. 7 shows the flux density variations along the lines 1 and 2.

- Along line 1, the increase of the interlaminar air gaps thickness leads to an increase of the heterogeneity of the magnetic flux density inside the stack. Indeed, compared to REF, a 3% increase of the magnetic flux density level in the saturated sheets as well as a 24% decrease of this level in the less solicited sheets can be noted when interlaminar air gaps are $15\mu\text{m}$.
- Along line 2, the increase of the interlaminar air gap thickness leads to an increase of the magnetic flux establishing itself in the plane of the sheets [12]. Indeed, the reluctance between the sheets increases with the interlaminar air gap thickness. This favors the in plane magnetization. In our case, the increase of the in plane magnetic flux density level is increased up to 3%.

The link between the change in arrangement of the magnetic flux due to the increase of the interlaminar air gaps and the

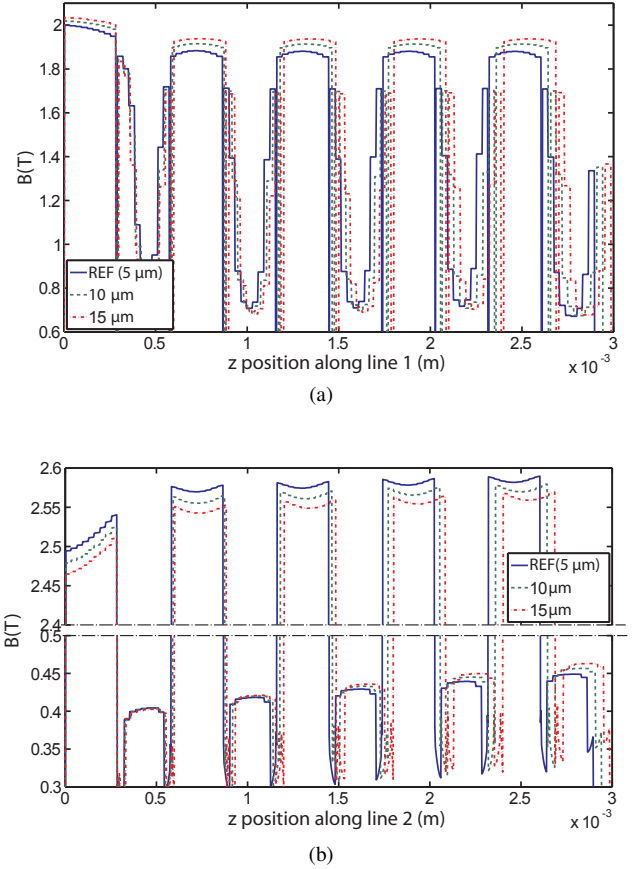

Fig. 7. Simulation results with homogeneous interlaminar air gaps along the line 1 (a) and the line 2 (b)

increase of the core losses can be explained in two different ways:

- the core losses have a non linear increase with respect to the magnetic flux density [13] and they are known to be minimal with a homogeneously distributed magnetic flux. Now, Fig. 7 shows that the increase of the interlaminar air gaps leads to an increase of the heterogeneity of the magnetic flux repartition in the stack. In our case, applying the results obtained along line 1 to a typical loss curve leads to an increase of the core losses up to 10% between the $5\mu\text{m}$ case and the $15\mu\text{m}$ case,
- Fig. 7b, as for it, shows an increase of the magnetic flux in the plane of the sheets, and so an increase of the rotational flux. The latter are known to be source of additional core losses [14].

C. Case 2

All the interlaminar air gaps are of the same thickness ($5\mu\text{m}$) excepted one of $15\mu\text{m}$. Two simulations have been done considering two different places for this particular air gap. In the first simulation, the larger air gap is placed in the middle of the stack (noted Middle Air Gap: MAG). In the second simulation, this larger air gap is placed at the extremity of the stack (noted Last Air Gap: LAG). Figs. 8a and 8b show the magnetic flux density repartition along lines 1 and 2. It can be noted that the influence of the increase of a single air

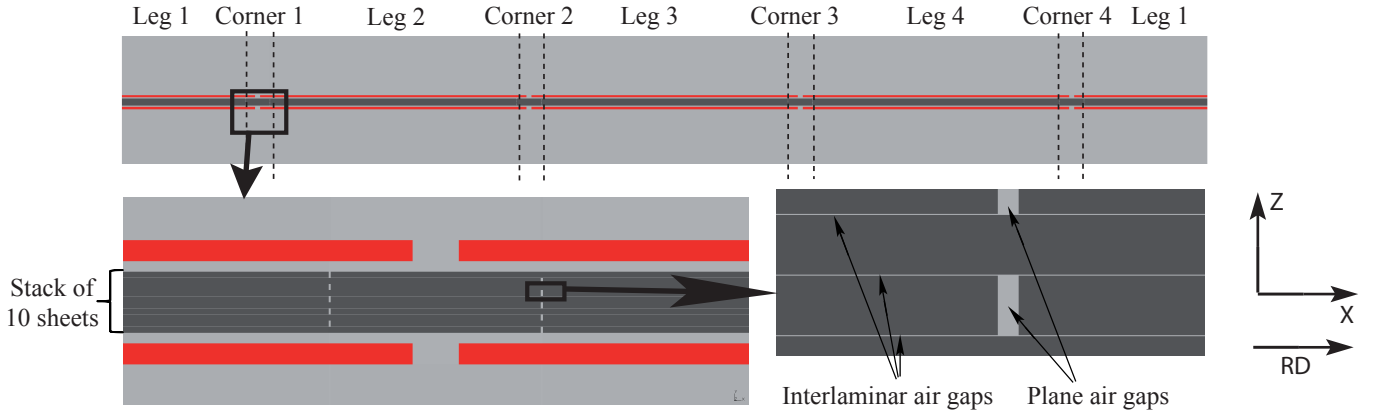

Fig. 5. Model for performing the Finite Element simulation of schematic outline transformer

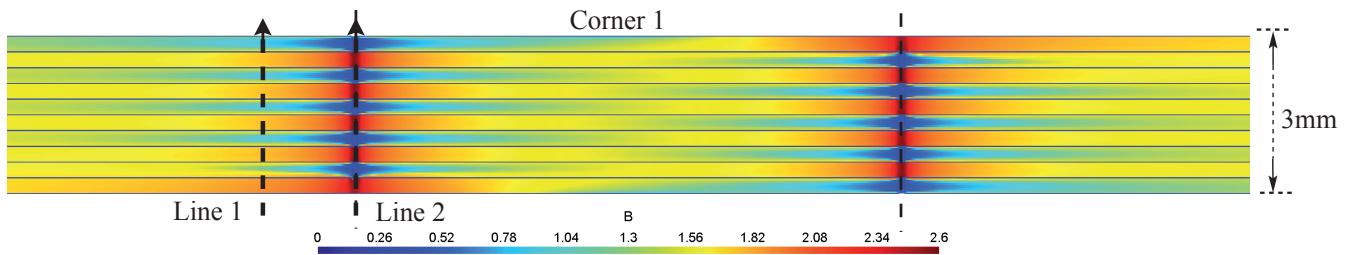

Fig. 6. Magnetic flux density distribution when all the interlaminar air gaps have the same thickness ($5 \mu\text{m}$)

gap on the repartition of the magnetic flux is limited to the contiguous sheets to this particular air gap only.

D. Case 3

In this case, the thickness values of the nine interlaminar air gaps are different from each others and follow the law $e_n = 5 + 0.1 \times 2^{n-2}$ (in μm) where n is the label of the considered air gap ($1 < n < 9$). This arrangement of the air gap thicknesses can be considered as equivalent to what happens in a vibrating transformer corner.

The results shown in Fig. 9 are in accordance with the two previous cases:

- the heterogeneity of the magnetic flux increases with the increase of the value of the interlaminar air gap thicknesses,
- the influence of the value of an air gap thickness is limited to the neighbouring sheets to this air gap. Indeed, Fig. 9 shows that the most important saturation phenomena are located around the larger air gap.

In this case, applying the results obtained along line 1 to a typical losses curve leads to an increase of the core losses up to 3% compared to the reference case.

IV. RESULTS AND DISCUSSION

The measurements performed on a single phase transformer core presented in section II showed that there is a link between the core deformations and the core losses. Indeed, applying a pressure perpendicular to the lamination surface at a transformer corner leads to a reduction of both the core

vibrations and the core losses. Actually, the latter increase with a heterogeneous distribution of the magnetic flux density inside the transformer core, as well as with local saturations. The FE model presented in section III showed that those two phenomena are themselves linked to the thickness of the interlaminar air gaps.

V. CONCLUSION

In this paper, the authors have shown the importance of the clamping in a transformer. A lack of clamping or a non-uniform one has a direct influence on the core losses. Indeed, the natural vibrations of the transformer lead to a heterogeneous repartition of the thickness of the interlaminar air gaps. Hence, the increase of the latter presents a direct impact on the repartition of the magnetic flux inside the transformer and then to the core losses, especially in the corners.

ACKNOWLEDGMENT

This work is supported by the French national technological research cluster on electrical machine efficiency increase (MEDEE). This program, including ThyssenKrupp Electrical Steel UGO, is sponsored by the region Nord Pas-de-Calais (France), the French ministry and the European funds (FEDER).

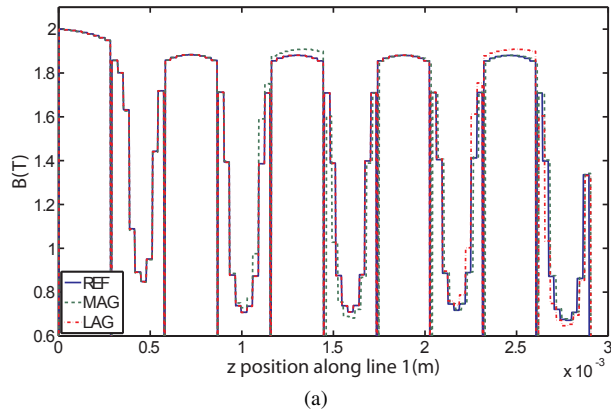

(a)

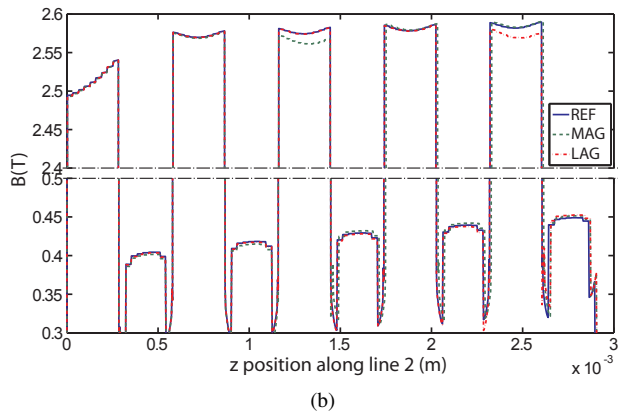

(b)

Fig. 8. Simulation results with one air gap thickness different from the others along the line 1 (a) and the line 2 (b)

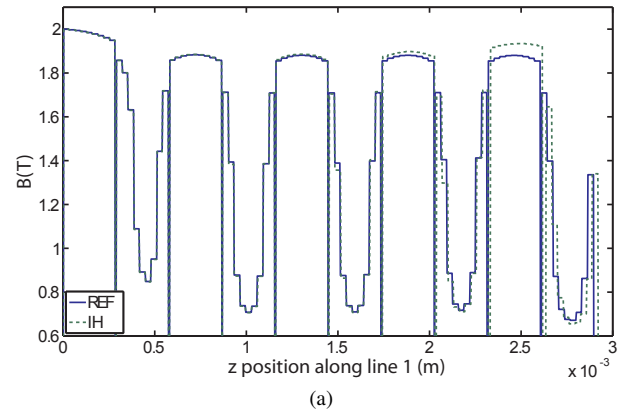

(a)

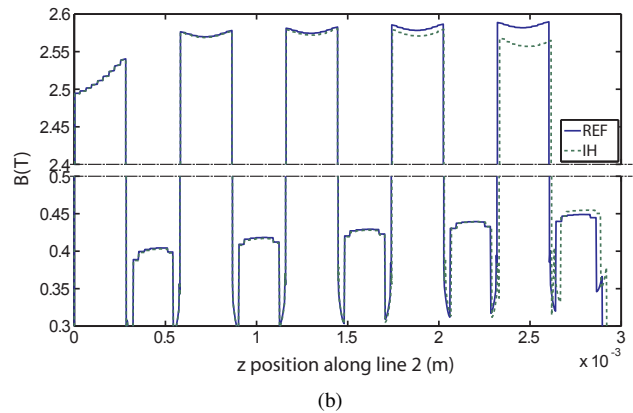

(b)

Fig. 9. Simulation results with non-homogeneous interlaminar air gaps along the line 1 (a) and the line 2 (b)

REFERENCES

- [1] P. Joslin, A. Moses, and J. Thompson, "Some aspects of effects of longitudinal and normal stress on power loss and flux distribution within a transformer core," *Electrical Engineers, Proceedings of the Institution of*, vol. 119, no. 6, pp. 709–716, May 1972.
- [2] A. Moses, "Effects of stresses on magnetic properties of silicon-iron laminations," *Journal of Materials Science*, vol. 9, no. 2, pp. 217–222, 1974.
- [3] S. Arai, M. Mizokami, and M. Yabumoto, "Magnetostriction of grain oriented Si-Fe and its domain model," *Przegląd Elektrotechniczny*, vol. 87, pp. 20–23, 2011.
- [4] B. Weiser, H. Pfützner, and J. Anger, "Relevance of magnetostriction and forces for the generation of audible noise of transformer cores," *IEEE Trans. Magn.*, vol. 36, no. 5, pp. 3759–3777, Sep. 2000.
- [5] Y. Wang, J. Pan, and M. Jin, "Finite element modelling of the vibration of a power transformer," in *Proceedings of ACOUSTICS, Paper*, no. 34, 2011.
- [6] G. F. Mechler and R. S. Girgis, "Magnetic flux distributions in transformer core joints," *IEEE Trans. Power Del.*, vol. 15, no. 1, pp. 198–203, Jan. 2000.
- [7] T. Nakata, N. Takahashi, and Y. Kawase, "Magnetic performance of Step-Lap joints in distribution transformer cores," *IEEE Trans. Magn.*, vol. 18, no. 6, pp. 1055–1057, Nov. 1982.
- [8] G. Parent, R. Penin, J.-P. Lecoite, J.-F. Brudny, and T. Belgrand, "Analysis of the magnetic flux distribution in a new shifted non-segmented grain oriented AC motor magnetic circuit," *IEEE Trans. Magn.*, vol. 49, no. 5, pp. 1977–1980, May 2013.
- [9] *IEC 60404-2: Methods of measurement of the magnetic properties of electrical steel sheet and strip by means of an Epstein frame*, IEC Std., 2008.
- [10] N. Hihat, K. Komeza, E. Napieralska Juszcak, and J. P. Lecoite, "Experimental and numerical characterization of magnetically anisotropic laminations in the direction normal to their surface," *IEEE Trans. Magn.*, vol. 47, no. 11, pp. 4517–4522, Nov. 2011.
- [11] N. Hihat, E. Napieralska, J.-P. Lecoite, J. Sykulski, and K. Komeza, "Equivalent permeability of Step-Lap joints of transformer cores: Computational and experimental considerations," *IEEE Trans. Magn.*, vol. 47, no. 1, pp. 244–251, Jan. 2011, fl : 1.06.
- [12] M. B. Balehosur, P. Marketos, A. J. Moses, and J. N. Vincent, "Packet-to-packet variation of flux density in a three-phase, three-limb power transformer core," *IEEE Trans. Magn.*, vol. 46, no. 2, pp. 642–645, Feb. 2010.
- [13] G. Bertotti, "General properties of power losses in soft ferromagnetic materials," *IEEE Trans. Magn.*, vol. 24, no. 1, pp. 621–630, Jan. 1988.
- [14] M. Jones and A. J. Moses, "Comparison of the localized power loss and flux distribution in the butt and lap and mitred overlap corner configurations," *IEEE Trans. Magn.*, vol. 10, no. 2, pp. 321–326, Jun. 1974.